



■ Features :

- Universal AC input / Full range
- Built-in active PFC function, PF>0.95
- High efficiency up to 90%
- **Optional L-Bracket and cover (ELP-75-x-C, x=3,3,5,12,15,24,36,48)**
- Protections: Short circuit / Overload / Over voltage
- Cooling by free air convection • 1U low profile
- LED indicator for power on
- No load power consumption<0.5W
- 3 years warranty



SPECIFICATION

MODEL	ELP-75-3.3	ELP-75-5	ELP-75-12	ELP-75-15	ELP-75-24	ELP-75-36	ELP-75-48	
OUTPUT	DC VOLTAGE	3.3V	5V	12V	15V	24V	36V	48V
	RATED CURRENT	15A	15A	6.25A	5A	3.15A	2.1A	1.6A
	CURRENT RANGE	0 ~ 15A	0 ~ 15A	0 ~ 6.25A	0 ~ 5A	0 ~ 3.15A	0 ~ 2.1A	0 ~ 1.6A
	RATED POWER	49.5W	75W	75W	75W	75.6W	75.6W	76.8W
	RIPPLE & NOISE (max.) Note.2	80mVp-p	80mVp-p	120mVp-p	150mVp-p	240mVp-p	280mVp-p	300mVp-p
	VOLTAGE ADJ. RANGE	3 ~ 3.6V	4.75 ~ 5.5V	10.8 ~ 13.2V	13.5 ~ 16.5V	21.6 ~ 26.4V	32.4 ~ 39.6V	43.2 ~ 52.8V
	VOLTAGE TOLERANCE Note.3	±3.0%	±2.0%	±2.0%	±2.0%	±1.0%	±1.0%	±1.0%
	LINE REGULATION	±0.5%	±0.5%	±0.5%	±0.5%	±0.5%	±0.5%	±0.5%
	LOAD REGULATION	±2.0%	±1.5%	±1.0%	±1.0%	±1.0%	±1.0%	±1.0%
	SETUP, RISE TIME	2500ms, 50ms/230VAC 2500ms, 50ms/115VAC at full load						
HOLD UP TIME (Typ.)	20ms/230VAC 20ms/115VAC at full load							
INPUT	VOLTAGE RANGE Note.6	90 ~ 264VAC 127 ~ 370VDC						
	FREQUENCY RANGE	47 ~ 63Hz						
	POWER FACTOR (Typ.) Note.5	3.3V: PF>0.91/230VAC		5V~48V: PF>0.95/230VAC		PF>0.98/115VAC at full load		
	EFFICIENCY (Typ.)	80%	82%	89%	90%	90%	90%	90%
	AC CURRENT (Typ.)	1.8A/115VAC		1 A/230VAC				
	INRUSH CURRENT (Typ.)	COLD START 60A/230VAC						
	LEAKAGE CURRENT	<1mA/240VAC						
PROTECTION	OVER LOAD	105 ~ 150% rated output power Protection type : Hiccup mode, recovers automatically after fault condition is removed						
	OVER VOLTAGE	3.7 ~ 4.45V	5.6 ~ 6.75V	13.8 ~ 16.2V	17.25 ~ 20.25V	27.6 ~ 32.4V	39.7 ~ 46.8V	53.3 ~ 64.8V
ENVIRONMENT	WORKING TEMP.	-30 ~ +70°C (Refer to "Derating Curve")						
	WORKING HUMIDITY	20 ~ 90% RH non-condensing						
	STORAGE TEMP., HUMIDITY	-40 ~ +85°C, 10 ~ 95% RH						
	TEMP. COEFFICIENT	±0.03%/°C(0 ~ 50°C)						
	VIBRATION	10 ~ 500Hz, 2G 10min./1cycle, period for 60min. each along X, Y, Z axes						
SAFETY & EMC (Note 4)	SAFETY STANDARDS	UL60950-1, TUV EN60950-1 approved						
	WITHSTAND VOLTAGE	I/P-O/P:3KVAC		I/P-FG:2KVAC		O/P-FG:0.5KVAC		
	ISOLATION RESISTANCE	I/P-O/P, I/P-FG, O/P-FG:100M Ohms / 500VDC/ 500VDC / 25°C/ 70% RH						
	EMC EMISSION	Compliance to EN55032 (CISPR32) Class B, EN61000-3-2,-3						
	EMC IMMUNITY	Compliance to EN61000-4-2,3,4,5,6,8,11; EN55024, heavy industry level, criteria A						
OTHERS	MTBF	345.3Khrs min. MIL-HDBK-217F (25°C)						
	DIMENSION	PCB:175*60*27mm (L*W*H) with optional CASE:195*68.5*33mm (L*W*H)						
	PACKING	PCB:0.25Kg; 48pcs/13Kg/0.85CUFT with optional CASE:0.54Kg; 25pcs/14.5Kg/0.59CUFT						
NOTE	<ol style="list-style-type: none"> 1. All parameters NOT specially mentioned are measured at 230VAC input, rated load and 25°C of ambient temperature. 2. Ripple & noise are measured at 20MHz of bandwidth by using a 12" twisted pair-wire terminated with a 0.1uf & 47uf parallel capacitor. 3. Tolerance : includes set up tolerance, line regulation and load regulation. 4. The power supply is considered a component which will be installed into a final equipment. All the EMC tests are been executed by mounting the unit on a 360mm*360mm metal plate with 1mm of thickness. The final equipment must be re-confirmed that it still meets EMC directives. For guidance on how to perform these EMC tests, please refer to "EMI testing of component power supplies." (as available on http://www.meanwell.com) 5. 3.3V PF>0.92/230VAC, others PF>0.95/230VAC. 6. Derating may be needed under low input voltage. Please check the derating curve for more details. 							

Mechanical Specification

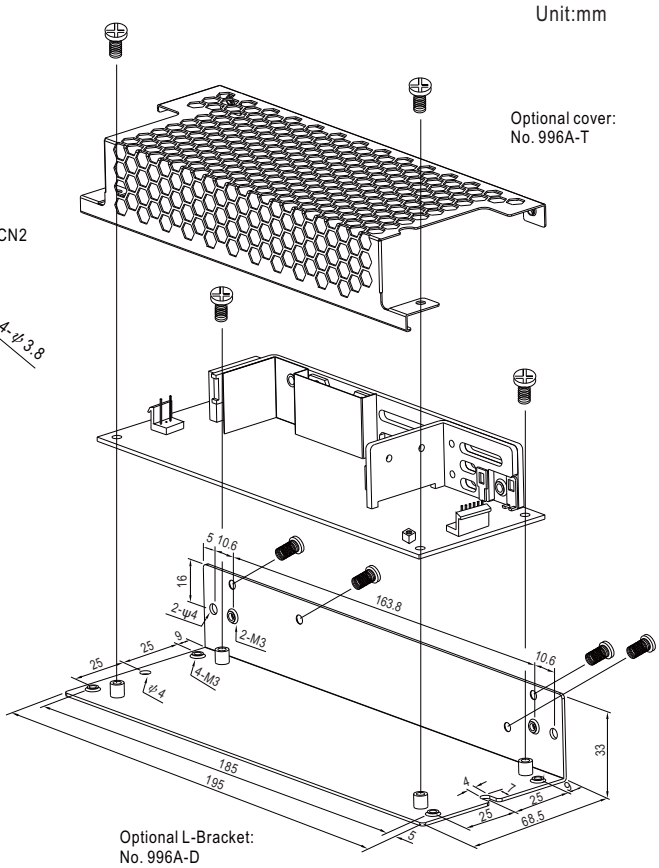
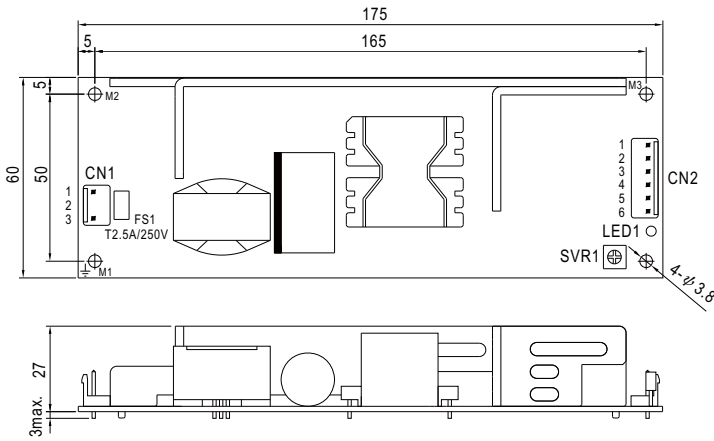

AC Input Connector (CN1) : JST B3P-VH or equivalent

Pin No.	Assignment	Mating Housing	Terminal
1	AC/L	JST VHR or equivalent	JST SVH-21T-P1.1 or equivalent
2	No Pin		
3	AC/N		

DC Output Connector (CN2) : JST B6P-VH or equivalent

Pin No.	Assignment	Mating Housing	Terminal
1,2,3	-V	JST VHR or equivalent	JST SVH-21T-P1.1 or equivalent
4,5,6	+V		

⊕ : Grounding Required

1.M1 is safety ground. For better EMC performance, Please secure an electrical connection between M1, M2, M3, and chassis grounding

Block Diagram

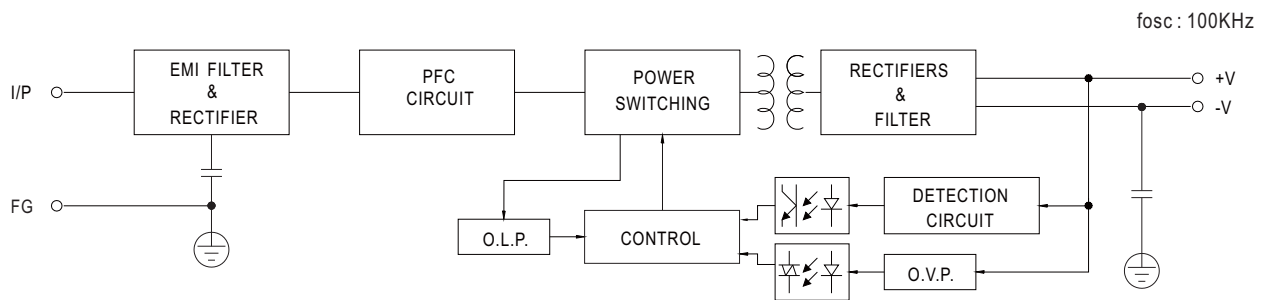

Output Derating

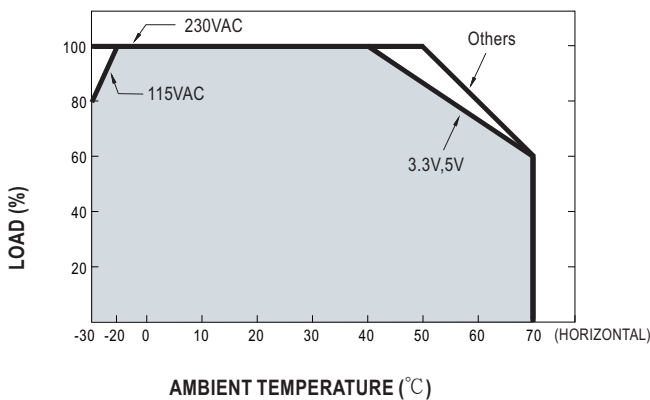

Output Derating VS Input Voltage

