

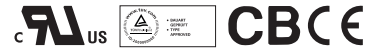

■ Features :

- Universal AC input / Full range
- Optional L-Bracket and cover
- High efficiency up to 90%
- Protections: Short circuit / Overload / Over voltage
- Cooling by free air convection
- 4"×2" compact size
- LED indicator for power on
- No load power consumption<0.3W
- 3 years warranty



EPS-45-3.3 -C =Blank, -C ; Blank=PCB only, -C=Enclosed type

SPECIFICATION

MODEL	EPS-45-3.3 <input type="checkbox"/>	EPS-45-5 <input type="checkbox"/>	EPS-45-7.5 <input type="checkbox"/>	EPS-45-12 <input type="checkbox"/>	EPS-45-15 <input type="checkbox"/>	EPS-45-24 <input type="checkbox"/>	EPS-45-36 <input type="checkbox"/>	EPS-45-48 <input type="checkbox"/>		
OUTPUT	DC VOLTAGE	3.3V	5V	7.5V	12V	15V	24V	36V	48V	
	RATED CURRENT	8A	8A	5.4A	3.75A	3A	1.9A	1.25A	1A	
	CURRENT RANGE	0 ~ 9A	0 ~ 9A	0 ~ 6A	0 ~ 4.2A	0 ~ 3.3A	0 ~ 2.1A	0 ~ 1.4A	0 ~ 1.1A	
	RATED POWER	26.4W	40W	40.5W	45W	45W	45.6W	45W	48W	
	PEAK LOAD(10sec.) Note.6	29.7W	45W	42W	50.4W	49.5W	50.4W	50.4W	52.8W	
	RIPPLE & NOISE (max.) Note.2	80mVp-p	80mVp-p	100mVp-p	120mVp-p	150mVp-p	240mVp-p	280mVp-p	300mVp-p	
	VOLTAGE ADJ. RANGE	3.1 ~ 3.6V	4.75 ~ 5.5V	7.13 ~ 8.25V	10.8 ~ 13.5V	13.5 ~ 16.5V	21.6 ~ 27V	32.4 ~ 39.6V	43.2 ~ 52.8V	
	VOLTAGE TOLERANCE Note.3	±3.0%	±2.0%	±2.0%	±2.0%	±2.0%	±1.0%	±1.0%	±1.0%	
	LINE REGULATION	±0.5%	±0.5%	±0.5%	±0.5%	±0.5%	±0.5%	±0.5%	±0.5%	
	LOAD REGULATION	±2.0%	±1.0%	±1.0%	±1.0%	±1.0%	±1.0%	±1.0%	±1.0%	
SETUP, RISE TIME	1000ms, 50ms/230VAC 2000ms, 50ms/115VAC at full load									
HOLD UP TIME (Typ.)	50ms/230VAC 16ms/115VAC at full load									
INPUT	VOLTAGE RANGE Note.5	90 ~ 264VAC 127 ~ 370VDC [DC input operation possible by connecting AC/N(+), AC/L(-)]								
	FREQUENCY RANGE	47 ~ 63Hz								
	EFFICIENCY (Typ.)	80%	82%	84%	87%	88%	89%	89%	90%	
	AC CURRENT (Typ.)	1.8A/115VAC 1 A/230VAC								
	INRUSH CURRENT (Typ.)	COLD START 60A/230VAC								
LEAKAGE CURRENT	<2mA/240VAC									
PROTECTION	OVER LOAD	115 ~ 160% rated output power Protection type : Hiccup mode, recovers automatically after fault condition is removed								
	OVER VOLTAGE	3.7 ~ 4.45V	5.6 ~ 6.75V	8.63 ~ 10.1V	13.8 ~ 16.2V	17.25 ~ 20.25V	27.6 ~ 32.4V	39.7 ~ 46.8V	53.3 ~ 64.8V	
ENVIRONMENT	WORKING TEMP.	-30 ~ +70°C (Refer to output load derating curve)								
	WORKING HUMIDITY	20 ~ 90% RH non-condensing								
	STORAGE TEMP., HUMIDITY	-40 ~ +85°C, 10 ~ 95% RH								
	TEMP. COEFFICIENT	±0.03%/°C (0 ~ 50°C)								
	VIBRATION	10 ~ 500Hz, 2G 10min./1cycle, period for 60min. each along X, Y, Z axes								
SAFETY & EMC (Note 4)	SAFETY STANDARDS	UL60950-1, TUV EN60950-1 approved								
	WITHSTAND VOLTAGE	I/P-O/P:3KVAC I/P-FG:2KVAC O/P-FG:0.5KVAC								
	ISOLATION RESISTANCE	I/P-O/P, I/P-FG, O/P-FG:100M Ohms / 500VDC / 25°C / 70% RH								
	EMC EMISSION	Compliance to EN55032 (CISPR32) Class B, EN61000-3-2,-3								
OTHERS	EMC IMMUNITY	Compliance to EN61000-4-2,3,4,5,6,8,11, EN55024, heavy industry level, criteria A								
	MTBF	652.3Khrs min. MIL-HDBK-217F (25°C)								
	DIMENSION	PCB:101.6*50.8*29mm (L*W*H) ; with optional CASE:103.4*62*37mm (L*W*H)								
	PACKING	PCB: 0.14Kg; 96pcs/ 14.5Kg/0.89CUFT ; with optional CASE: 0.3Kg; 45pcs/ 14.5Kg/0.67CUFT								
NOTE	<p>1. All parameters NOT specially mentioned are measured at 230VAC input, rated load and 25°C of ambient temperature.</p> <p>2. Ripple & noise are measured at 20MHz of bandwidth by using a 12" twisted pair-wire terminated with a 0.1uf & 47uf parallel capacitor.</p> <p>3. Tolerance : includes set up tolerance, line regulation and load regulation.</p> <p>4. Derating may be needed under low input voltage. Please check the static characteristics for more details.</p> <p>5. 33% Duty cycle maximum within every 30 seconds. Average output power should not exceed the rated power.</p> <p>6. The power supply is considered a component which will be installed into a final equipment. All the EMC tests are been executed by mounting the unit on a 360mm*360mm metal plate with 1mm of thickness. The final equipment must be re-confirmed that it still meets EMC directives. For guidance on how to perform these EMC tests, please refer to "EMI testing of component power supplies." (as available on http://www.meanwell.com)</p>									

Mechanical Specification

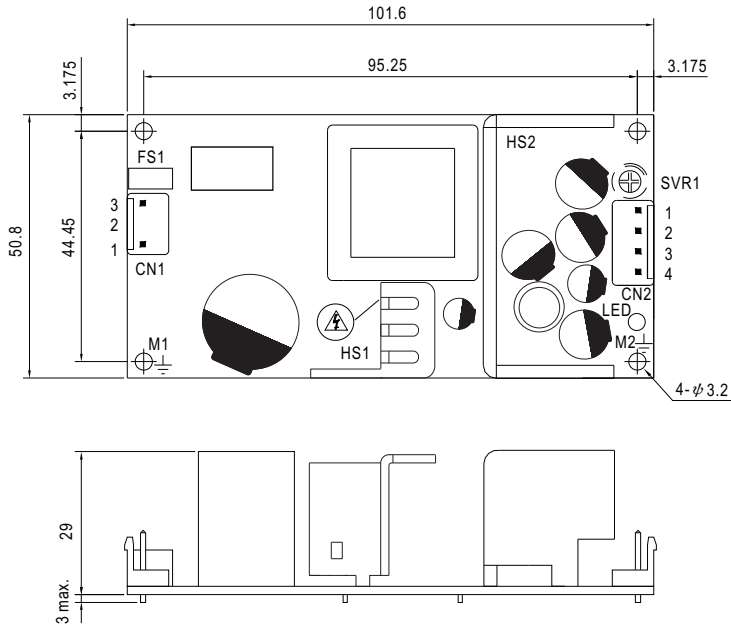

Unit:mm

Optional cover:
No.998A-T

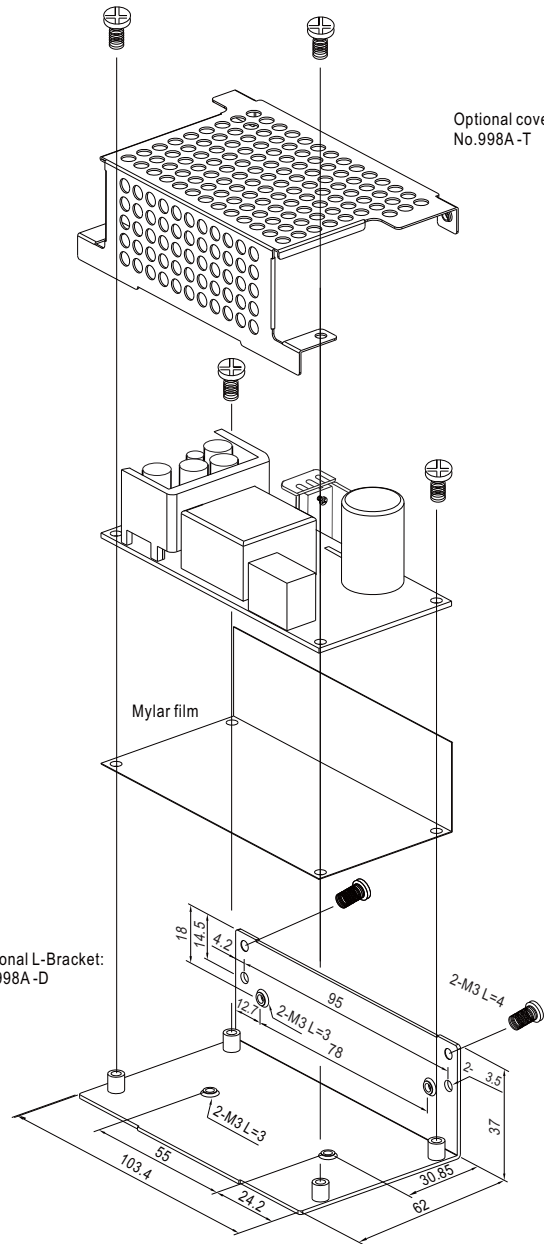

- 1.HS1,HS2 cannot be shorted.
- 2.HS1 must have safety isolation distance with system case.

AC Input Connector (CN1) : JST B3P-VH or equivalent

Pin No.	Assignment	Mating Housing	Terminal
1	AC/N	JST VHR or equivalent	JST SVH-21T-P1.1 or equivalent
2	No Pin		
3	AC/L		

DC Output Connector (CN2) : JST B4P-VH or equivalent

Pin No.	Assignment	Mating Housing	Terminal
1,2	+V	JST VHR or equivalent	JST SVH-21T-P1.1 or equivalent
3,4	-V		

⊥ : Grounding Required ;M1 and M2 are Safety ground and should all be grounded.

Block Diagram

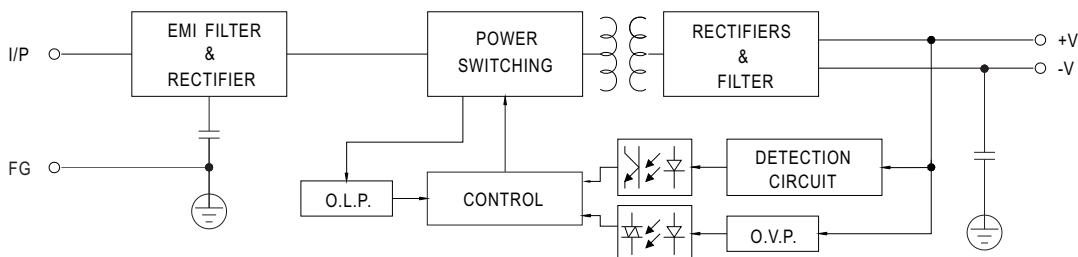

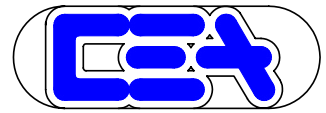

45W Single Output Switching Power Supply

EPS-45 series

■ Output Derating

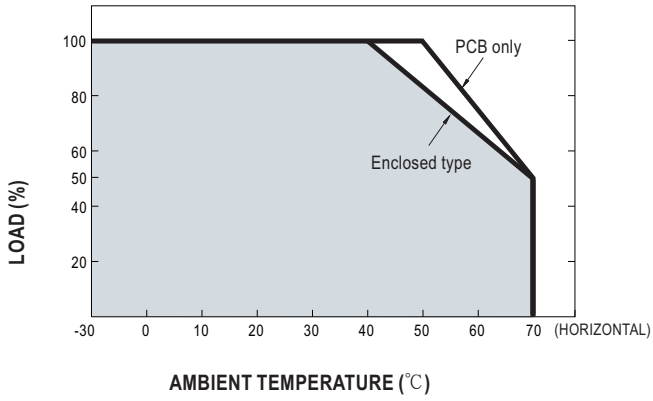

■ Static Characteristics

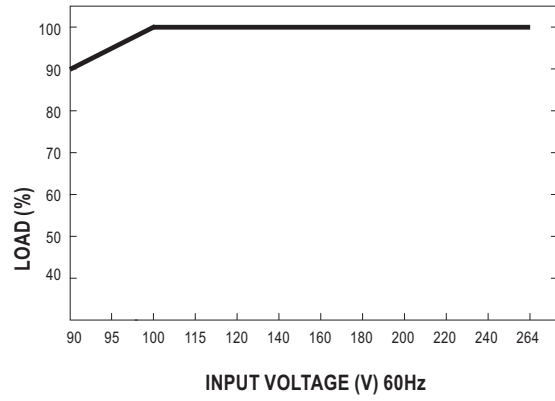

File Name:EPS-45-SPEC 2017-07-07



Note: all features are subject to change without notice.