



### ■ Features

- Constant Current mode output
- Circular plastic housing with class II design
- Built-in active PFC function
- Class 2 power unit
- Typical lifetime > 50000 hours
- 5 years warranty

### ■ Applications

- LED bay lighting
- LED stage lighting
- LED spot lighting
- LED down lighting

### ■ Description

HBG-60 series is a 60W AC/DC LED driver featuring the circular shape design with the plastic enclosure. It operates from 90~295VAC and offers the constant current output models with different rated current between 1050mA and 2100mA. Thanks to the high efficiency up to 90%, with the fanless design, the entire series is able to operate for -40°C ~ +85°C case temperature under free air convection.

### ■ Model Encoding

**HBG - 60 - 1050**

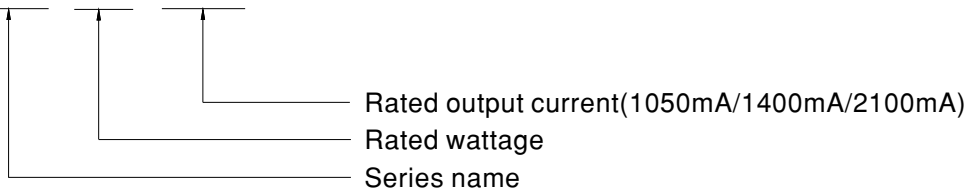

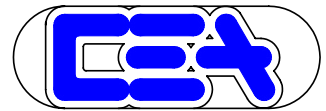

# HBG-60 series



## 60W Constant Current Mode LED Driver

### SPECIFICATION

MODEL	HBG-60-1050	HBG-60-1400	HBG-60-2100	
OUTPUT	RATED CURRENT	1050mA	1400mA	2100mA
	RATED POWER	57.75W	60.2W	60.9W
	CONSTANT CURRENT REGION <small>Note.2</small>	37 ~ 55V	28 ~ 43V	19 ~ 29V
	OPEN CIRCUIT VOLTAGE(max.)	60V	50V	35V
	CURRENT ADJ. RANGE	680 ~ 1050mA	910 ~ 1400mA	1360mA ~ 2100mA
	CURRENT RIPPLE	20% max. @rated current		
	CURRENT TOLERANCE	±5.0%		
SET UP TIME <small>Note.4</small>	500ms / 230VAC 1200ms / 115VAC			
INPUT	VOLTAGE RANGE <small>Note.3</small>	90 ~ 295VAC 127 ~ 417VDC (Please refer to "STATIC CHARACTERISTIC" section)		
	FREQUENCY RANGE	47 ~ 63Hz		
	POWER FACTOR	PF>0.97/115VAC, PF>0.95/230VAC, PF>0.9/277VAC@full load (Please refer to "POWER FACTOR (PF) CHARACTERISTIC" section)		
	TOTAL HARMONIC DISTORTION	THD< 20% (@load≥65%/115VAC, 230VAC; @load≥75%/277VAC) (Please refer to "TOTAL HARMONIC DISTORTION(THD)" section)		
	EFFICIENCY (Typ.)	90%	89%	89%
	AC CURRENT (Typ.)	0.7A/115VAC	0.4A/230VAC	0.3A/277VAC
	INRUSH CURRENT (Typ.)	COLD START 45A(twidth=100µs measured at 50% Ipeak) at 230VAC; Per NEMA 410		
	MAX. No. of PSUs on 16A CIRCUIT BREAKER	28 units (circuit breaker of type B) / 32 units (circuit breaker of type C) at 230VAC		
	LEAKAGE CURRENT	<0.75mA / 277VAC		
PROTECTION	OVER CURRENT	Hiccup mode, recovers automatically after fault condition is removed		
	OVER TEMPERATURE	Shut down o/p voltage, re-power on to recover		
ENVIRONMENT	WORKING TEMP.	Tcase=-40 ~ +85°C (Please refer to "OUTPUT LOAD vs TEMPERATURE" section)		
	MAX. CASE TEMP.	Tcase=+85°C		
	WORKING HUMIDITY	20 ~ 95% RH non-condensing		
	STORAGE TEMP., HUMIDITY	-40 ~ +80°C, 10 ~ 95% RH		
	TEMP. COEFFICIENT	±0.03%/°C (0 ~ 60°C)		
SAFETY & EMC	VIBRATION	10 ~ 500Hz, 5G 12min./1cycle, period for 72min. each along X, Y, Z axes		
	SAFETY STANDARDS	UL8750, CSA C22.2 No. 250.13-12, ENEC EN61347-1, EN61347-2-13 independent, EN62384; GB19510.14, GB19510.1 approved		
	WITHSTAND VOLTAGE	I/P-O/P:3.75KVAC		
	ISOLATION RESISTANCE	I/P-O/P:100M Ohms / 500VDC / 25°C/ 70% RH		
	EMC EMISSION <small>Note.8</small>	Compliance to EN55015, GB17743, GB17625.1, EN61000-3-2 Class C (@load ≥ 65%); EN61000-3-3		
	EMC IMMUNITY	Compliance to EN61000-4-2,3,4,5,6,8,11; EN61547, EN55024, light industry level(surge immunity:Line-Line:2KV)		
OTHERS	MTBF	1504.1K hrs min. Telcordia SR-332 (Bellcore); 452Khrs min. MIL-HDBK-217F (25°C)		
	DIMENSION	φ 110mm * 60.5mm (D * H)		
	PACKING	0.5Kg; 20pcs/ 11Kg/ 0.94CUFT		
NOTE	<ol style="list-style-type: none"> <li>All parameters NOT specially mentioned are measured at 230VAC input, rated current and 25°C of ambient temperature.</li> <li>Please refer to "DRIVING METHODS OF LED MODULE".</li> <li>De-rating may be needed under low input voltages. Please refer to "STATIC CHARACTERISTIC" sections for details.</li> <li>Length of set up time is measured at cold first start. Turning ON/OFF the driver may lead to increase of the set up time.</li> <li>The driver is considered as a component that will be operated in combination with final equipment. Since EMC performance will be affected by the complete installation, the final equipment manufacturers must re-qualify EMC Directive on the complete installation again.</li> <li>To fulfill requirements of the latest ErP regulation for lighting fixtures, this LED driver can only be used behind a switch without permanently connected to the mains.</li> <li>This series meets the typical life expectancy of &gt;50,000 hours of operation when Tcase, particularly (Tc) point (or TMP, per DLC), is about 80°C or less.</li> <li>Please refer to the warranty statement on MEAN WELL's website at <a href="http://www.meanwell.com">http://www.meanwell.com</a></li> </ol>			

File Name:HBG-60-SPEC 2016-06-16



Note: all features are subject to change without notice.

■ **BLOCK DIAGRAM**

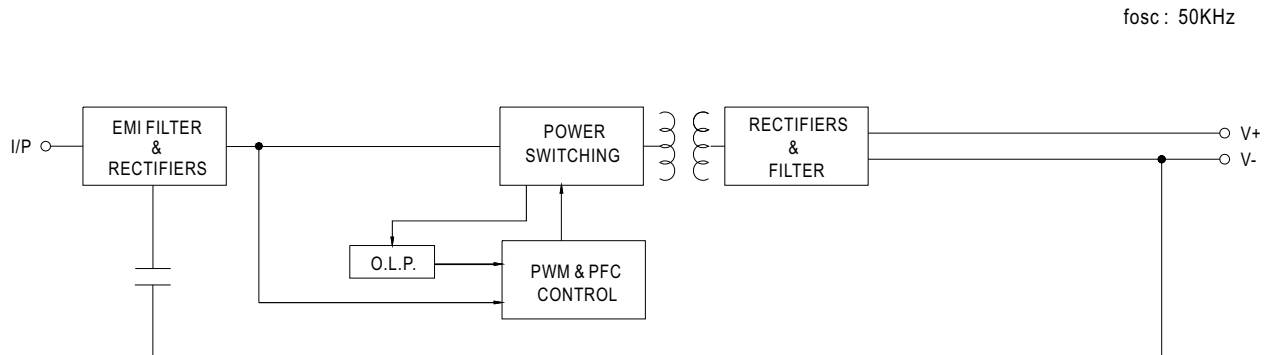

■ **DRIVING METHODS OF LED MODULE**

※ This series works in constant current mode to directly drive the LEDs.

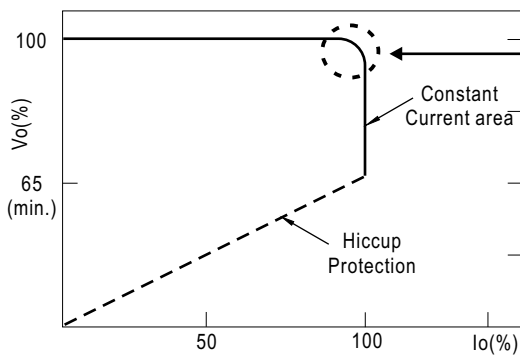

In the constant current region, the highest voltage at the output of the driver depends on the configuration of the end systems.  
Should there be any compatibility issues, please contact MEAN WELL.

Typical output current normalized by rated current (%)

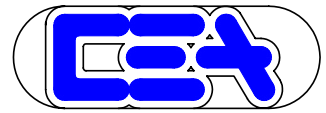

**OUTPUT LOAD vs TEMPERATURE**

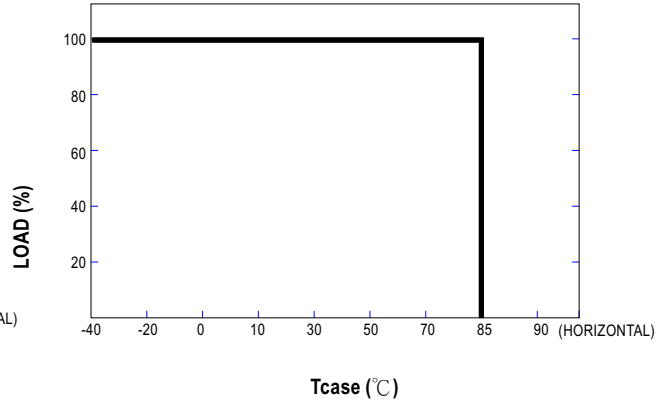
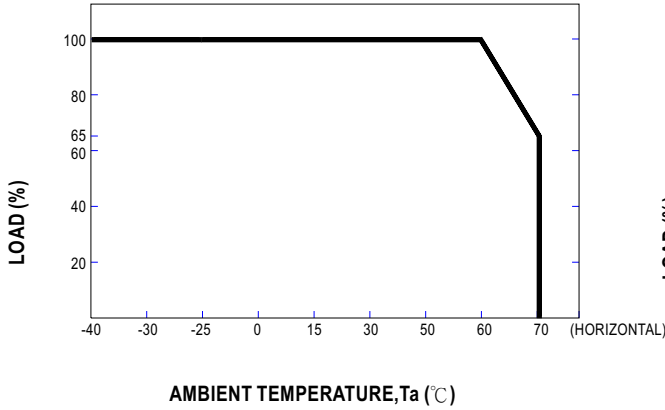

**STATIC CHARACTERISTIC**

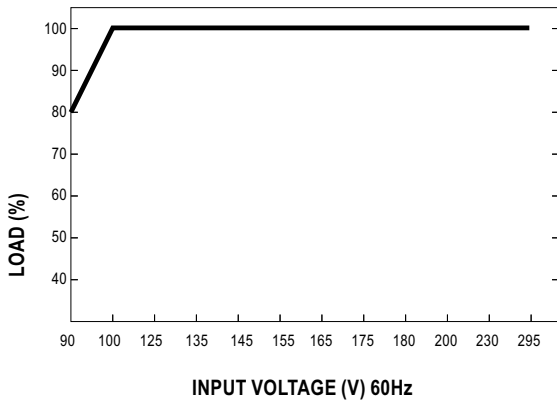

※ De-rating is needed under low input voltage.

**POWER FACTOR (PF) CHARACTERISTIC**

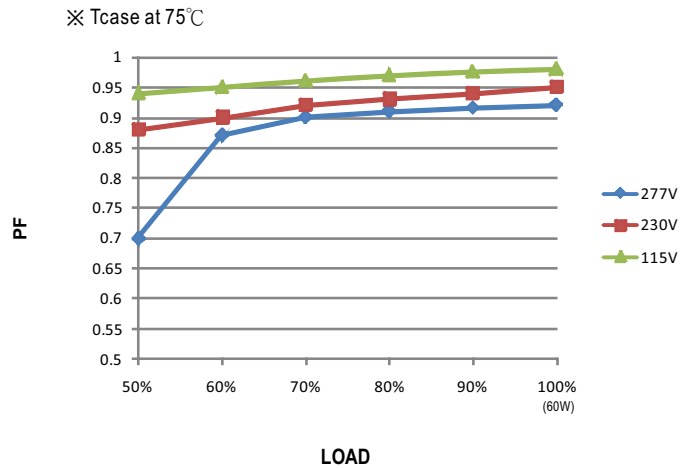

**TOTAL HARMONIC DISTORTION (THD)**

※ 1050mA Model, Tcase at 75°C

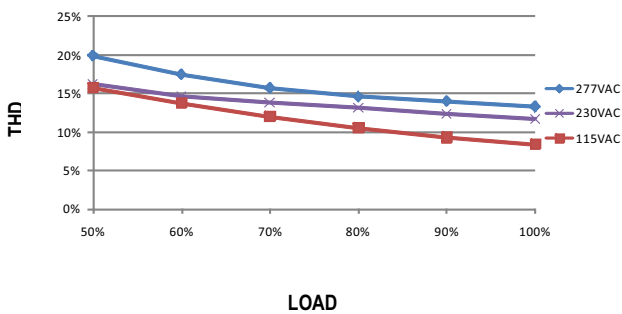

**EFFICIENCY vs LOAD**

HBG-60 series possess superior working efficiency that up to 90% can be reached in field applications.

※ 1050mA Model, Tcase at 75°C

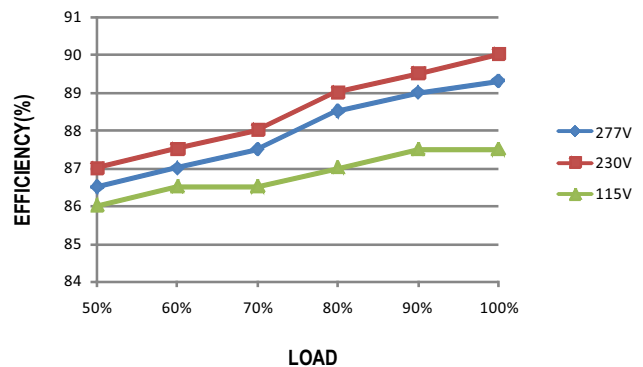

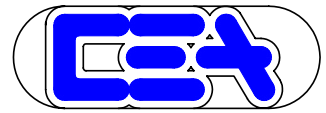

60W Constant Current Mode LED Driver

**HBG-60** series

■ LIFE TIME

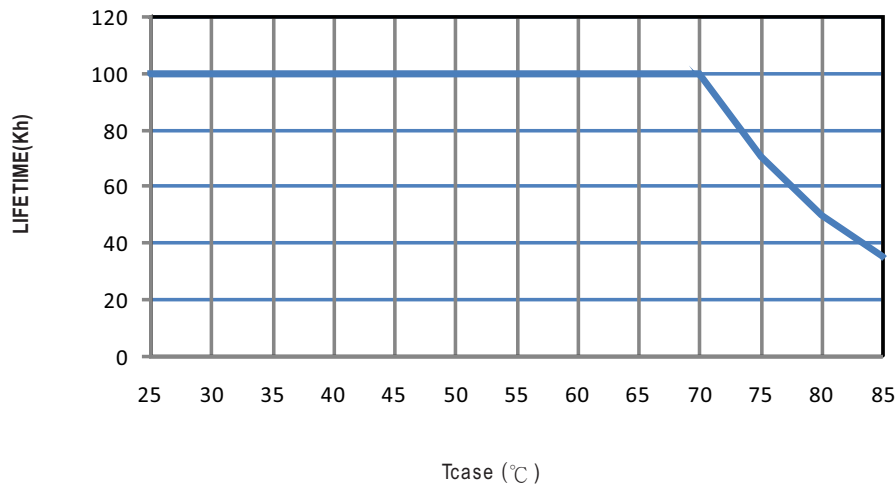

File Name: HBG-60-SPEC 2016-06-16



Note: all features are subject to change without notice.

MECHANICAL SPECIFICATION

Case No.HBG-60 Unit:mm

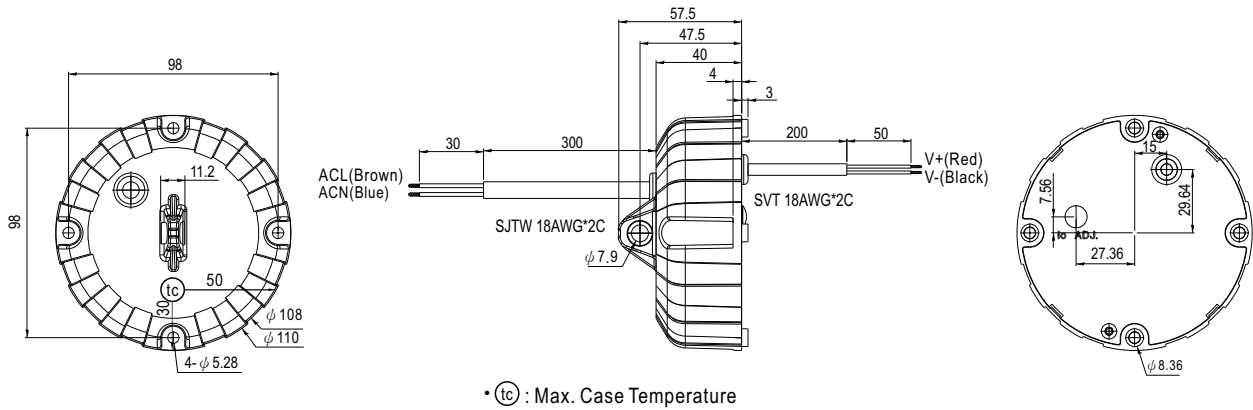

**Caution**

- ※ Please inspect the appearance of the driver if the package is damaged. There should not be any cracks.
- ※ Please do not drop or bump the driver.
- ※ All screws including the suspension screw should be paired with a spring washer and locked tight.
- ※ The entire luminaire, including the driver, should be limited to 5Kg or less.
- ※ The luminaire should be cautiously protected from damage due to shock throughout packaging and transportation.
- ※ Please thoroughly follow the preceding cautionary notes to prevent the luminaire from falling, leading to injuries.