



### ■ Features

- Constant Current mode output
- Metal housing with Class I design
- Built-in active PFC function
- IP67 / IP65 design for indoor or outdoor installations
- Function options: output adjustable via potentiometer; 3 in 1 dimming; Timer dimming
- Typical lifetime > 62000 hours
- 7 years warranty

### ■ Applications

- LED street lighting
- LED fishing lamp
- LED harbor lighting
- LED building architectural lighting
- LED bay lighting

### ■ Description

HLG-185H-C series is a 200W AC/DC LED power supply featuring the constant current mode and high voltage output. HLG-185H-C operates from 90~305VAC and offers models with different rated current ranging between 500mA and 1400mA. Thanks to the high efficiency up to 94%, with the fanless design, the entire series is able to operate for -40°C ~ +90°C case temperature under free air convection. The design of metal housing and IP67/IP65 ingress protection level allows this series to fit both indoor and outdoor applications. HLG-185H-C is equipped with various function options, such as dimming methodologies, so as to provide the optimal design flexibility for LED lighting system.

### ■ Model Encoding

**HLG - 185H - C700 A**

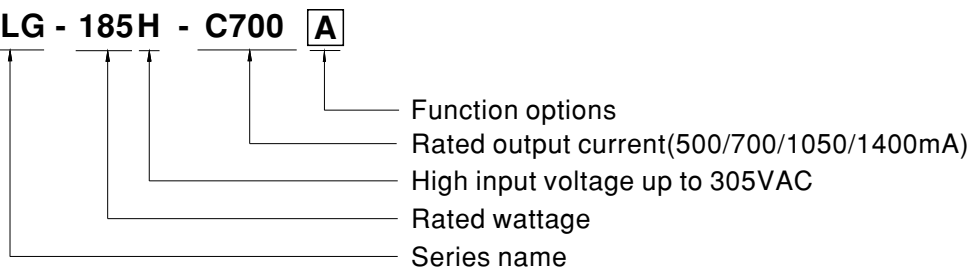

Type	IP Level	Function	Note
A	IP65	Io adjustable through built-in potentiometer.	In Stock
B	IP67	3 in 1 dimming function (1~10Vdc, 10V PWM signal and resistance)	In Stock
D	IP67	Timer dimming function, contact MEAN WELL for details(safety pending).	By request



200W Constant Current Mode LED Driver

HLG-185H-C series

## SPECIFICATION

MODEL		HLG-185H-C500 □	HLG-185H-C700 □	HLG-185H-C1050 □	HLG-185H-C1400 □
OUTPUT	RATED CURRENT	500mA	700mA	1050mA	1400mA
	RATED POWER	200W	200.2W	199.5W	200.2W
	CONSTANT CURRENT REGION <small>Note.2</small>	200V ~ 400V	143V ~ 286V	95V ~ 190V	71V ~ 143V
	CURRENT ADJ. RANGE	Can be adjusted by internal potentiometer (A type only)			
		250 ~ 500mA	350 ~ 700mA	525 ~ 1050mA	700 ~ 1400mA
	CURRENT RIPPLE	5.0% max. @rated current			
	CURRENT TOLERANCE	±5%			
SET UP TIME <small>Note.4</small>	1000ms/115VAC 500ms/230VAC				
INPUT	VOLTAGE RANGE <small>Note.3</small>	90 ~ 305VAC 127 ~ 431VDC (Please refer to "STATIC CHARACTERISTIC" section)			
	FREQUENCY RANGE	47 ~ 63Hz			
	POWER FACTOR (Typ.)	PF ≥ 0.98/115VAC or PF ≥ 0.96/230VAC or PF ≥ 0.94/277VAC @full load (Please refer to "POWER FACTOR (PF) CHARACTERISTIC" section)			
	TOTAL HARMONIC DISTORTION	THD < 20% @ ≥ 50% load/115VAC, or 230VAC, or @ ≥ 75% load/277VAC (Please refer to "TOTAL HARMONIC DISTORTION" section)			
	EFFICIENCY (Typ.)	94%	94%	94%	94%
	AC CURRENT (Typ.)	2A / 115VAC	1A / 230VAC	0.85A / 277VAC	
	INRUSH CURRENT(Typ.)	COLD START 55A(twidth=900μs measured at 50% Ipeak) at 230VAC; Per NEMA 410			
	MAX. No. of PSUs on 16A CIRCUIT BREAKER	2 units (circuit breaker of type B) / 3 units (circuit breaker of type C) at 230VAC			
	LEAKAGE CURRENT	<0.75mA / 277VAC			
PROTECTION	SHORT CIRCUIT	Constant current limiting, recovers automatically after fault condition is removed			
	OVER VOLTAGE	450 ~ 470V	320 ~ 340V	210 ~ 225V	160 ~ 170V
	OVER TEMPERATURE	Shut down o/p voltage, recovers automatically after temperature goes down			
ENVIRONMENT	WORKING TEMP.	Tcase=-40 ~ +90°C (Refer to "Derating Curve")			
	MAX. CASE TEMP.	Tcase=+90°C			
	WORKING HUMIDITY	10 ~ 95% RH non-condensing			
	STORAGE TEMP., HUMIDITY	-40 ~ +80°C, 10 ~ 95% RH			
	TEMP. COEFFICIENT	±0.03%/°C (0 ~ 50°C)			
	VIBRATION	10 ~ 500Hz, 5G 12min./1cycle, period for 72min. each along X, Y, Z axes;			
SAFETY & EMC	SAFETY STANDARDS	UL8750, CSA C22.2 No. 250.13-12, IEC EN61347-1, EN61347-2-13, EN62384 independent, GB19510.1, GB19510.14; IP65 or IP67, J61347-1, J61347-2-13 approved			
	WITHSTAND VOLTAGE	I/P-O/P:3.75KVAC I/P-FG:2KVAC O/P-FG:1.5KVAC			
	ISOLATION RESISTANCE	I/P-O/P, I/P-FG, O/P-FG:100M Ohms / 500VDC / 25°C / 70% RH			
	EMC EMISSION	Compliance to EN55015, EN61000-3-2 Class C (≥ 50% load) ; EN61000-3-3, GB17743 and GB17625.1			
	EMC IMMUNITY	Compliance to EN61000-4-2,3,4,5,6,8,11, EN61547, heavy industry level (surge immunity Line-Earth 4KV, Line-Line 2KV)			
OTHERS	MTBF	651.1K hrs min. Telcordia SR-332 (Bellcore) ; 191.9K hrs min. MIL-HDBK-217F (25°C)			
	DIMENSION	228*68*38.8mm (L*W*H)			
	PACKING	1.15Kg; 12pcs/14.8Kg/0.8CUFT			
NOTE	<ol style="list-style-type: none"> <li>All parameters NOT specially mentioned are measured at 230VAC input, rated current and 25°C of ambient temperature.</li> <li>Please refer to "DRIVING METHODS OF LED MODULE".</li> <li>De-rating may be needed under low input voltages. Please refer to "STATIC CHARACTERISTIC" sections for details.</li> <li>Length of set up time is measured at first cold start. Turning ON/OFF the driver may lead to increase of the set up time.</li> <li>The driver is considered as a component that will be operated in combination with final equipment. Since EMC performance will be affected by the complete installation, the final equipment manufacturers must re-qualify EMC Directive on the complete installation again.</li> <li>To fulfill requirements of the latest ErP regulation for lighting fixtures, this LED driver can only be used behind a switch without permanently connected to the mains.</li> <li>This series meets the typical life expectancy of &gt;62,000 hours of operation when Tcase, particularly (tc) point (or TMP, per DLC), is about 75°C or less.</li> <li>Please refer to the warranty statement on MEAN WELL's website at <a href="http://www.meanwell.com">http://www.meanwell.com</a></li> </ol>				

File Name:HLG-185H-C-SPEC 2017-07-14



Note: all features are subject to change without notice.

Costruzioni Elettroniche Elettromeccaniche & Affini s.r.l. - 10132 TORINO - C.so Casale, 413 - Tel. 0118987106 / 0115534597 - fax 0115534597 - e\_mail cea@cea.to - URL <http://www.cea.to>

**■ BLOCK DIAGRAM**

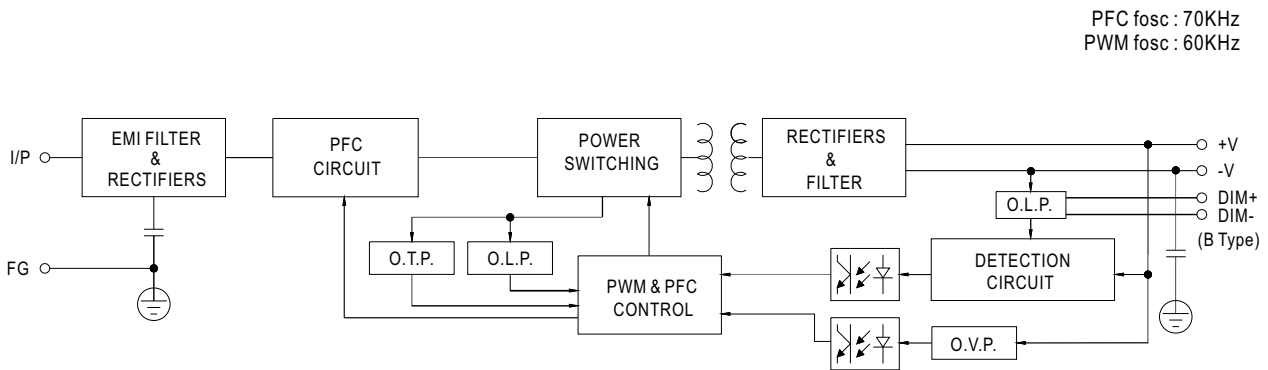

**■ DRIVING METHODS OF LED MODULE**

※ This series works in constant current mode to directly drive the LEDs.

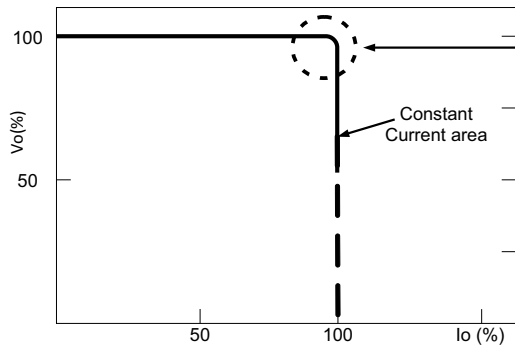

Typical output current normalized by rated current (%)

In the constant current region, the highest voltage at the output of the driver depends on the configuration of the end systems.

Should there be any compatibility issues, please contact MEAN WELL.

**■ DIMMING OPERATION**

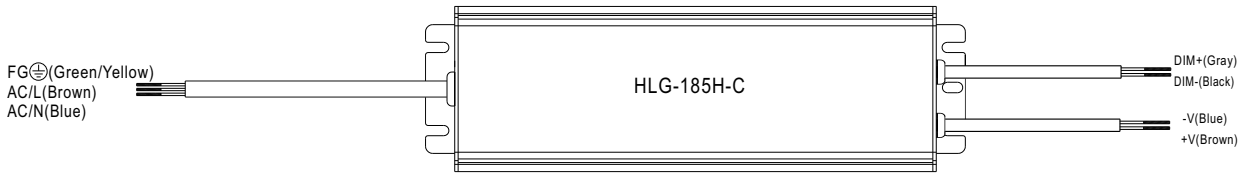

※ **3 in 1 dimming function (for B-Type)**

- Output constant current level can be adjusted by applying one of the three methodologies between DIM+ and DIM-: 1 ~ 10VDC, or 10V PWM signal or resistance.
- Direct connecting to LEDs is suggested. It is not suitable to be used with additional drivers.
- Dimming source current from power supply: 100 $\mu$ A (typ.)

◎ Applying additive 1 ~ 10VDC

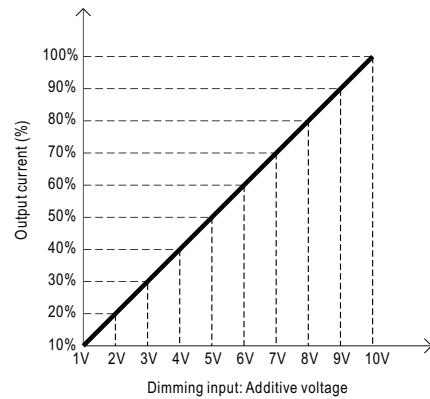
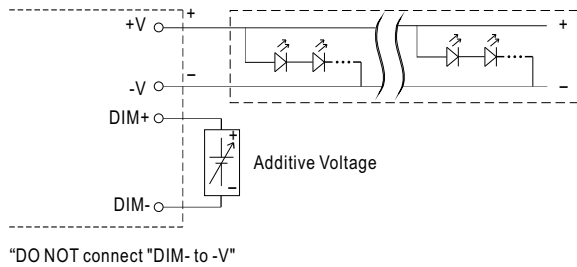

◎ Applying additive 10V PWM signal (frequency range 100Hz ~ 3KHz):

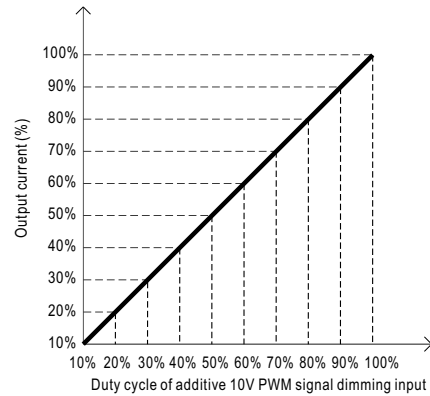
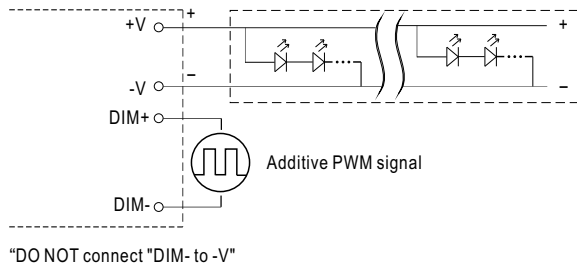

◎ Applying additive resistance:

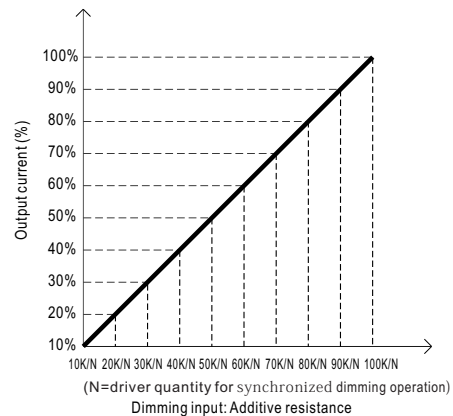
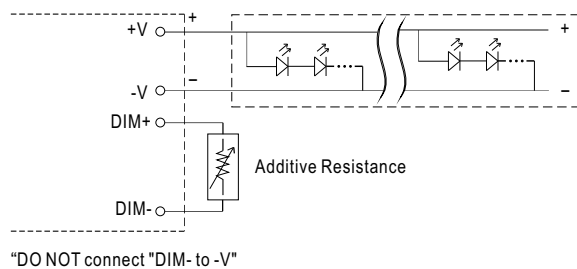

Note: In the case of turning the lighting fixture down to 0% brightness, please refer to the configuration as follow, or please contact MEAN WELL for other options.

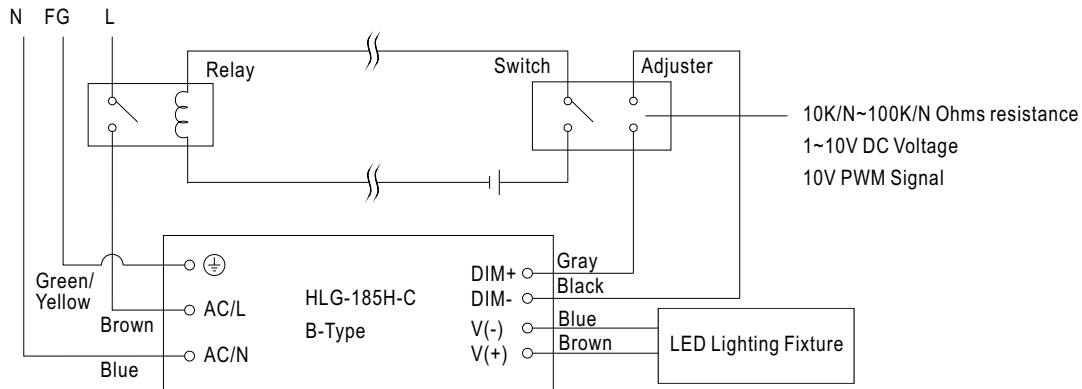

Using a switch and relay can turn ON/OFF the lighting fixture.

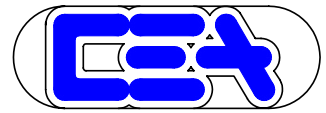

200W Constant Current Mode LED Driver

HLG-185H-C series

**OUTPUT LOAD vs TEMPERATURE**

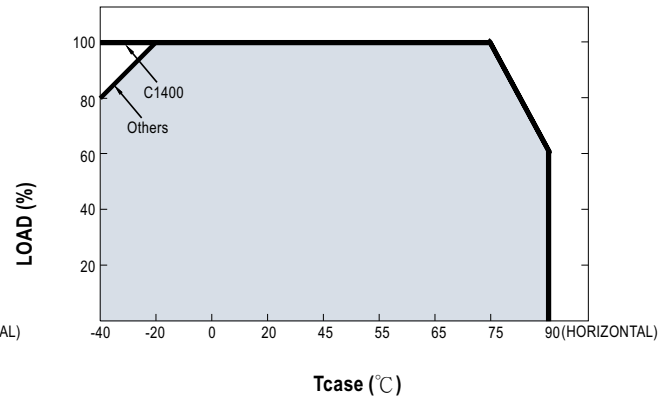
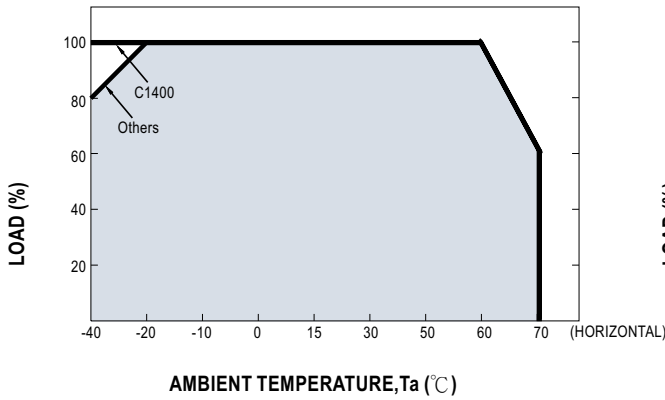

**STATIC CHARACTERISTIC**

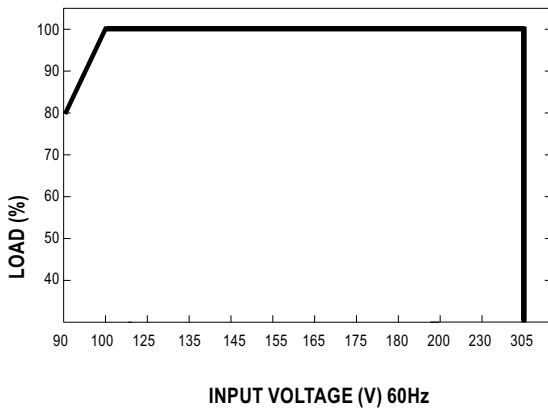

**POWER FACTOR (PF) CHARACTERISTIC**

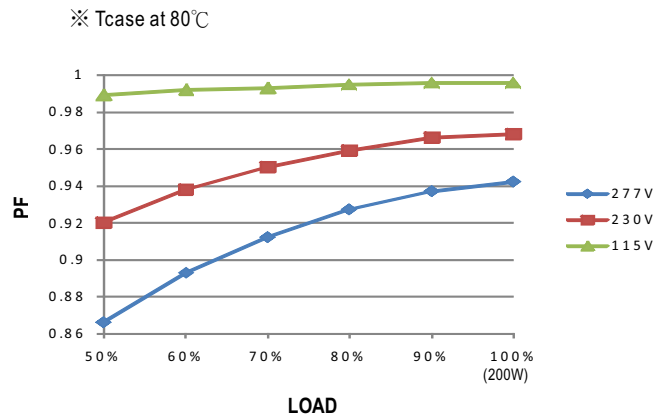

**TOTAL HARMONIC DISTORTION (THD)**

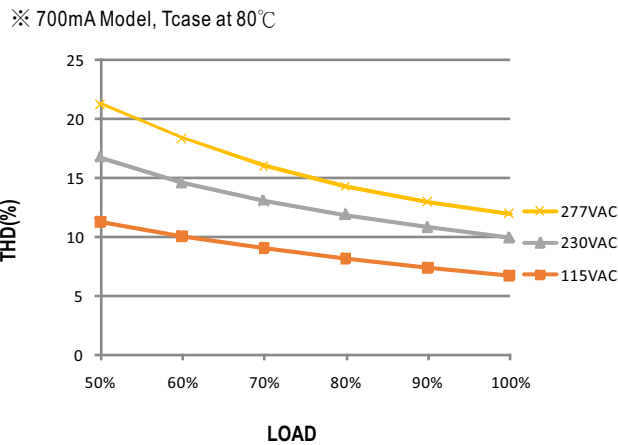

**EFFICIENCY vs LOAD**

HLG-185H-C series possess superior working efficiency that up to 94% can be reached in field applications.

※ 700mA Model, Tcase at 80°C

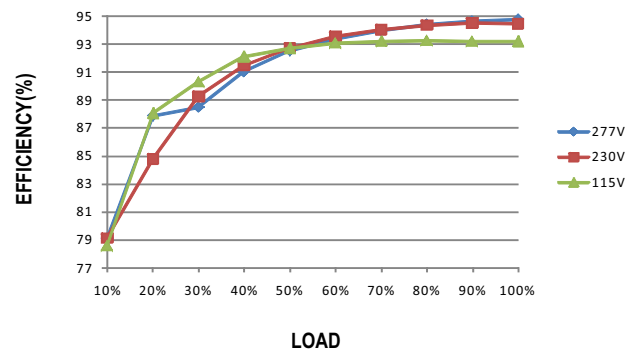

File Name:HLG-185H-C-SPEC 2017-07-14



Note: all features are subject to change without notice.

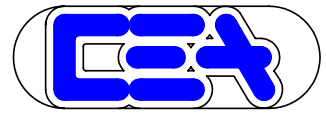

200W Constant Current Mode LED Driver

**HLG-185H-C** series

■ LIFE TIME

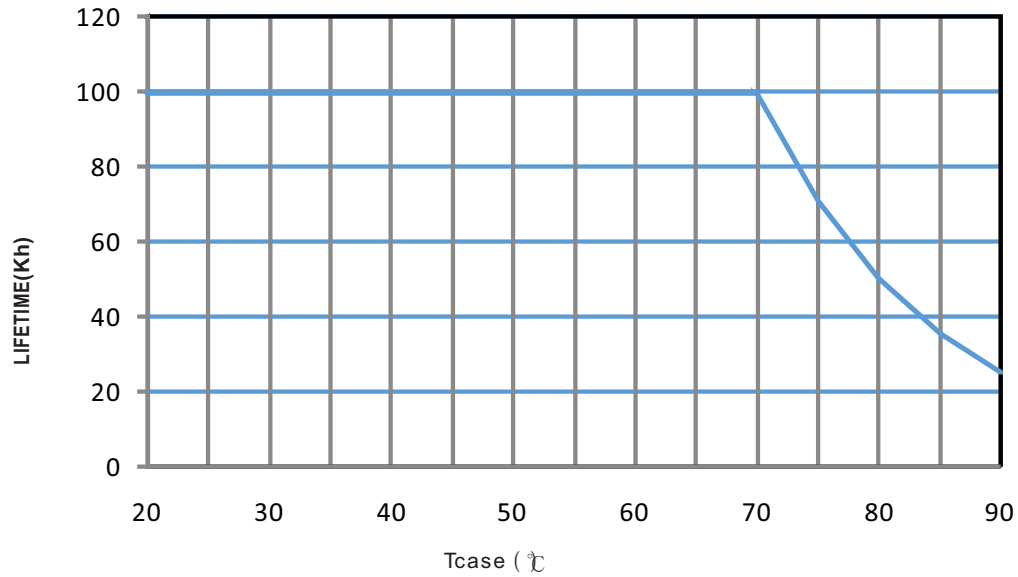

File Name:HLG-185H-C-SPEC 2017-07-14



Note: all features are subject to change without notice.

MECHANICAL SPECIFICATION

Case No.994D Unit:mm

※ A-Type

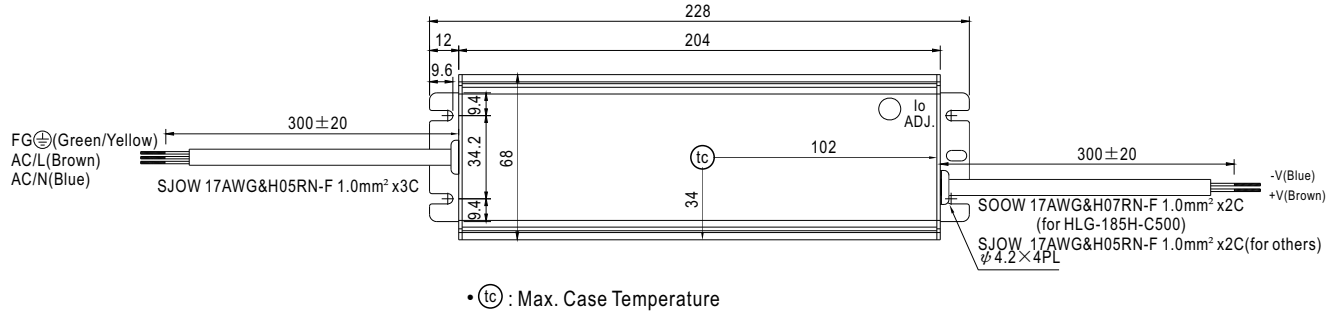

• tc : Max. Case Temperature

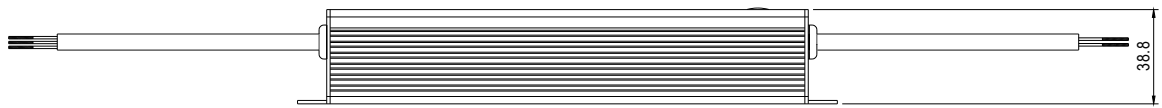

※ B-Type

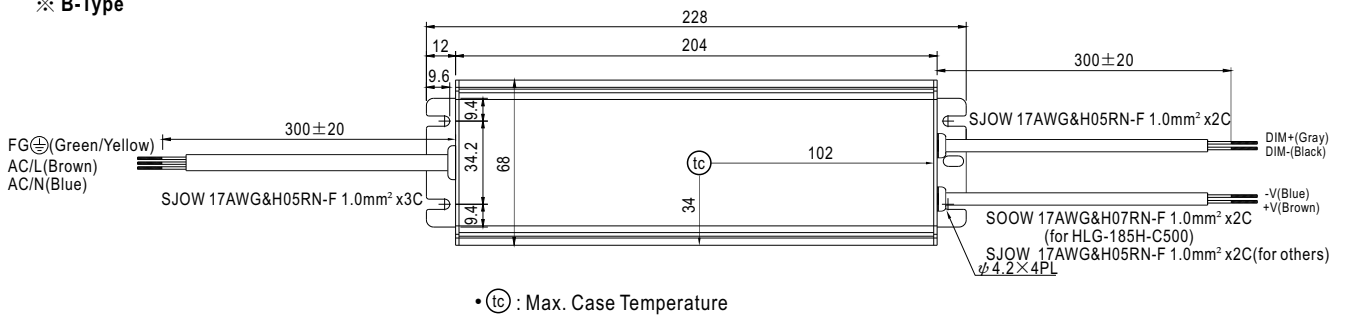

• tc : Max. Case Temperature

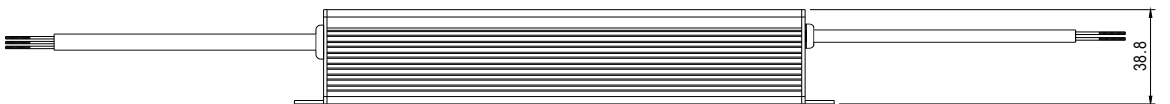

※ D-Type

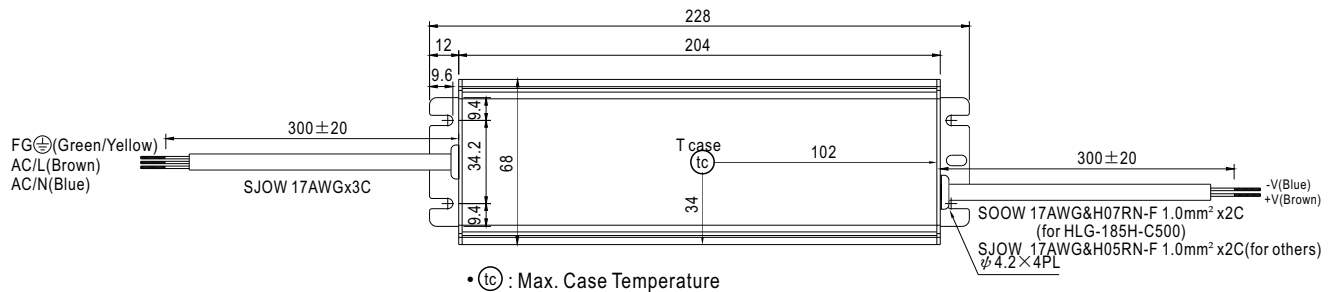

• tc : Max. Case Temperature





**WATERPROOF CONNECTION**

◎ Waterproof connector

Waterproof connector can be assembled on the output cable of HLG-185H-C to operate in dry/wet/damp or outdoor environment.

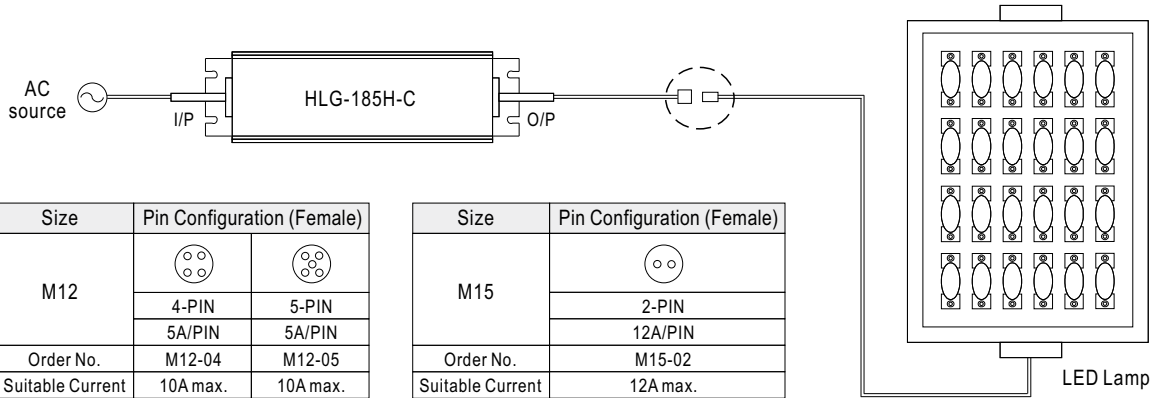

◎ Cable Joiner

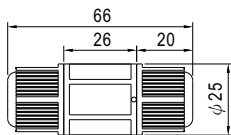

CJ04-1 suitable for 14AWG~16AWG  
CJ04-2 suitable for 18AWG~22AWG



Up to four wires can be connected through this cable joiner by soldering or clamping by tools.

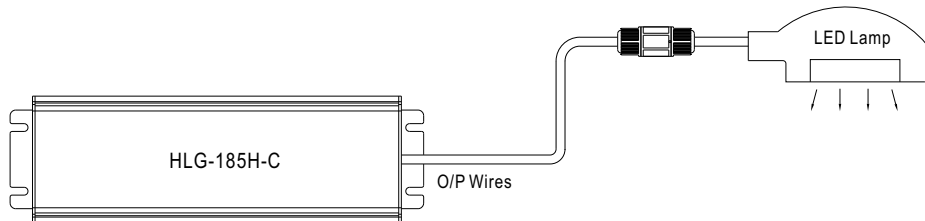
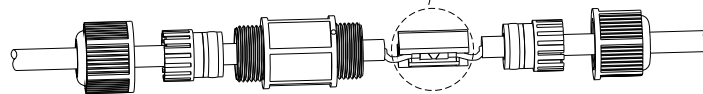

※CJ04 cable joiner can be purchased independently for user's own assembly.  
MEAN WELL order No. : CJ04-1, CJ04-2.

**INSTALLATION MANUAL**

Please refer to : <http://www.meanwell.com/manual.html>