

Features

- 5"×3" compact size
- Medical safety approved (2 x MOPP) according to ANSI/AAMI ES60601-1 and IEC/EN60601-1
- Suitable for BF application with appropriate system consideration
- 200W convection, 300W force air
- EMI Class B for Class I & Class A for Class II configuration
- No load power consumption < 0.5W by PS-ON control
- Extremely low leakage current
- 5Vdc standby output, 12Vdc fan supply, Power Good, Power Fail and remote sense
- Protections: Short circuit / Overload / Over voltage / Over temperature
- Typical Lifetime > 40K hours
- 3 years warranty

Applications

- Oral irrigator
- Hemodialysis machine
- Medical computer monitors
- Sleep apnea devices
- Pump machine
- Electric bed

Description

RPS-300 is a 300W highly reliable green PCB type medical power supply with a high power density on the 5" by 3" footprint. It accepts 90~264VAC input and offers various output voltages between 12V and 48V. The working efficiency is up to 93% and the extremely low no load power consumption is down below 0.5W. The extremely low leakage current is less than 150 μA. In addition, it conforms to international medical regulations (2*MOPP) and EMC EN55011, perfectly fitting all kinds of BF rated "patient contact" medical system equipment. RPS-300 series also offers the enclosed style model (RPS-300-C).

Model Encoding

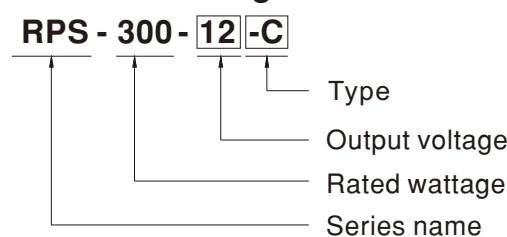

Type	Description	Note
Blank	PCB Type	In stock
C	Enclosed casing Type	In stock



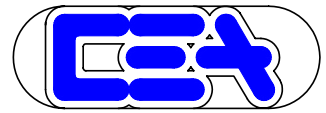

300W Reliable Green Medical Power Supply

RPS-300 series

SPECIFICATION

MODEL		RPS-300-12□	RPS-300-15□	RPS-300-24□	RPS-300-27□	RPS-300-48□	
OUTPUT	DC VOLTAGE	12V	15V	24V	27V	48V	
	RATED CURRENT (20.5CFM)	25A	20A	12.5A	11.12A	6.25A	
	CURRENT	Convection	0 ~ 16.67A	0 ~ 13.33A	0 ~ 8.33A	0 ~ 7.4A	0 ~ 4.17A
		20.5CFM	0 ~ 25A	0 ~ 20A	0 ~ 12.5A	0 ~ 11.12A	0 ~ 6.25A
	RATED POWER	Convection	200W	200W	200W	200W	200.2W
		20.5CFM	300W	300W	300W	300W	300W
	RIPPLE & NOISE (max.) Note.2	120mVp-p	120mVp-p	150mVp-p	200mVp-p	250mVp-p	
	VOLTAGE ADJ. RANGE (main output)	11.4 ~ 12.6V	14.25 ~ 15.75V	22.8 ~ 25.2V	25.65 ~ 28.35V	45.6 ~ 50.4V	
	VOLTAGE TOLERANCE Note.3	±3.0%	±3.0%	±2.0%	±2.0%	±2.0%	
	LINE REGULATION	±0.5%	±0.5%	±0.5%	±0.5%	±0.5%	
LOAD REGULATION	±1.0%	±1.0%	±1.0%	±1.0%	±1.0%		
SETUP, RISE TIME	2500ms, 30ms/230VAC 3000ms, 30ms/115VAC at full load						
HOLD UP TIME (Typ.)	16ms/230VAC/115VAC at full load						
INPUT	VOLTAGE RANGE Note.4	90 ~ 264VAC 127 ~ 370VDC					
	FREQUENCY RANGE	47 ~ 63Hz					
	POWER FACTOR (Typ.)	PF>0.93/230VAC PF>0.98/115VAC at full load					
	EFFICIENCY (Typ.)	90%	90%	92.5%	93%	93%	
	AC CURRENT (Typ.)	3.5A/115VAC 1.8A/230VAC					
	INRUSH CURRENT (Typ.)	COLD START 35A/115VAC 70A/230VAC					
	LEAKAGE CURRENT(max.) Note.5	PCB Type: Earth leakage current <150μA / 264VAC, Touch current <70μA/264VAC Enclosed Type: Earth leakage current <200μA / 264VAC, Touch current <70μA/264VAC					
PROTECTION	OVERLOAD	105 ~ 135% rated output power Protection type : Hiccup mode, recovers automatically after fault condition is removed					
	OVER VOLTAGE	13.5 ~ 15V	16.2 ~ 18.5V	26 ~ 30V	29.5 ~ 33.5V	52 ~ 59.5V	
	OVER TEMPERATURE	Protection type : (TSW1) Shut down o/p voltage, recovers automatically after temperature goes down Protection type : (TSW2) Shut down o/p voltage, re-power on to recover					
FUNCTION	5V STANDBY	5Vsb : 5V@0.6A without fan, 1A with fan 20.5CFM ; tolerance ± 2%, ripple : 150mVp-p(max.)					
	FAN SUPPLY	12V@0.5A for driving a fan ; Tolerance -15% ~ +10%					
	PS-ON INPUT SIGNAL	Power on: PS-ON = "Hi" or " > 2 ~ 5V" ; Power off: PS-ON = "Low" or " < 0 ~ 0.5V"					
	POWER GOOD / POWER FAIL	500ms>PG>10ms ; The TTL signal goes high with 10ms to 500ms delay after power set up ; The TTL signal goes low at least 1ms before Vo below 90% of rated value					
ENVIRONMENT	WORKING TEMP.	-30 ~ +70°C (Refer to "Derating Curve")					
	WORKING HUMIDITY	20 ~ 90% RH non-condensing					
	STORAGE TEMP., HUMIDITY	-40 ~ +85°C , 10 ~ 95% RH non-condensing					
	TEMP. COEFFICIENT	±0.03%/°C (0 ~ 50°C)					
	VIBRATION	10 ~ 500Hz, 2G 10min./1cycle, 60min. each along X, Y, Z axes					
OPERATING ALTITUDE Note.6	4000 meters						

File Name:RPS-300-SPEC 2017-10-23



Note: all features are subject to change without notice.

Costruzioni Elettroniche Elettromeccaniche & Affini s.r.l. - 10132 TORINO - C.so Casale, 413 - Tel. 0118987106 / 0115534597 - fax 0115534597 - e_mail cea@cea.to - URL http://www.cea.to

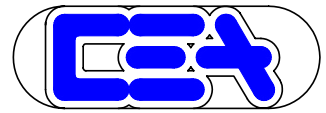

300W Reliable Green Medical Power Supply

RPS-300 series

SAFETY & EMC (Note 7)	SAFETY STANDARDS	IEC60601-1, TUV EN60601-1, UL ANSI / AAMI ES60601-1 (3.1 version), CAN/CSA-C22.2 No. 60601-1:14 - Edition 3 approved; Design refer to EN60335-1		
	ISOLATION LEVEL	Primary-Secondary: 2xMOPP, Primary-Earth:1xMOPP, Secondary-Earth:1xMOPP		
	WITHSTAND VOLTAGE	I/P-O/P:4KVAC I/P-FG:2KVAC O/P-FG:1.5KVAC		
	ISOLATION RESISTANCE	I/P-O/P, I/P-FG, O/P-FG:100M Ohms / 500VDC / 25°C / 70% RH		
	EMC EMISSION	Parameter	Standard	Test Level / Note
		Conducted emission	EN55011 (CISPR11)	Class B
		Radiated emission	EN55011 (CISPR11)	Class B
		Harmonic current	EN61000-3-2	Class A
	EMC IMMUNITY	EN60601-1-2		
		Parameter	Standard	Test Level / Note
ESD		EN61000-4-2	Level 4, 15KV air ; Level 4, 8KV contact	
RF field susceptibility		EN61000-4-3	Level 3, 10V/m(80MHz~2.7GHz) Table 9, 9~28V/m(385MHz~5.78GHz)	
EFT bursts		EN61000-4-4	Level 3, 2KV	
Surge susceptibility		EN61000-4-5	Level 4, 4KV/Line-FG ; 2KV/Line-Line	
Conducted susceptibility		EN61000-4-6	Level 3, 10V	
Magnetic field immunity		EN61000-4-8	Level 4, 30A/m	
OTHERS	MTBF	160Khrs min. MIL-HDBK-217F (25°C)		
	DIMENSION (L*W*H)	PCB type:127*76.2*35mm or 5"*3"*1.37"inch		
Enclosed type:130*86*43mm or 5.11"*3.39"*1.69"inch				
PACKING	PCB type:0.37Kg; 36pcs/14.3Kg/1.03CUFT			
	Enclosed type:0.563Kg; 24pcs/14.5Kg/0.77CUFT			
NOTE	<p>1. All parameters NOT specially mentioned are measured at 230VAC input, rated load and 25 of ambient temperature.</p> <p>2. Ripple & noise are measured at 20MHz of bandwidth by using a 12" twisted pair-wire terminated with a 0.1µf & 47µf parallel capacitor.</p> <p>3. Tolerance : includes set up tolerance, line regulation and load regulation.</p> <p>4. Derating may be needed under low input voltages. Please check the derating curve for more details.</p> <p>5. Touch current was measured from primary input to DC output.</p> <p>6. The ambient temperature derating of 2.5°C/ 1000m is needed for operating altitude greater than 2000m(6500ft).</p> <p>7. The power supply is considered a component which will be installed into a final equipment. All the Class I (with FG) EMC tests are executed by mounting the unit on a 360mm*360mm metal plate with 1mm of thickness. The Class II (without FG) EMC tests are executed by mounting the unit on a 130mm*86.6mm metal plate with 1mm of thickness. The final equipment must be re-confirmed that it still meets EMC directives. For guidance on how to perform these EMC tests, please refer to "EMI testing of component power supplies." (as available on http://www.meanwell.com)</p>			

File Name:RPS-300-SPEC 2017-10-23



Note: all features are subject to change without notice.

Costruzioni Elettroniche Elettromeccaniche & Affini s.r.l. - 10132 TORINO - C.so Casale, 413 - Tel. 0118987106 / 0115534597 - fax 0115534597 - e_mail cea@cea.to - URL <http://www.cea.to>

■ Block Diagram

PFC fosc : 65KHz
PWM fosc : 70KHz

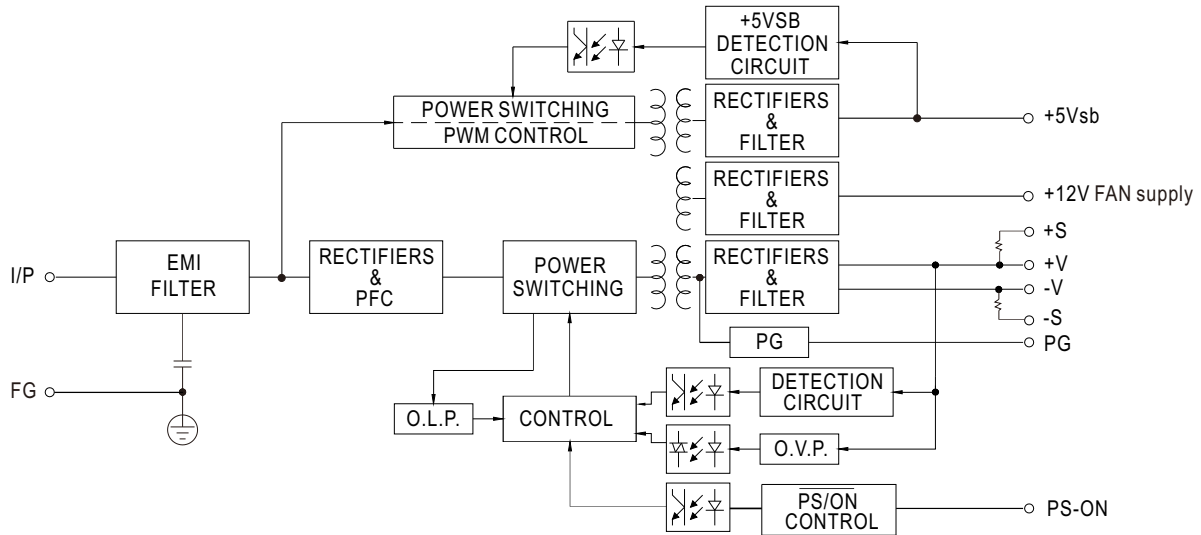

■ Derating Curve

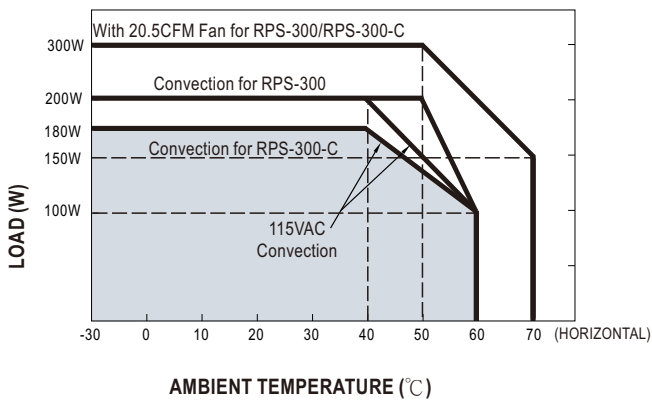

■ Output Derating VS Input Voltage

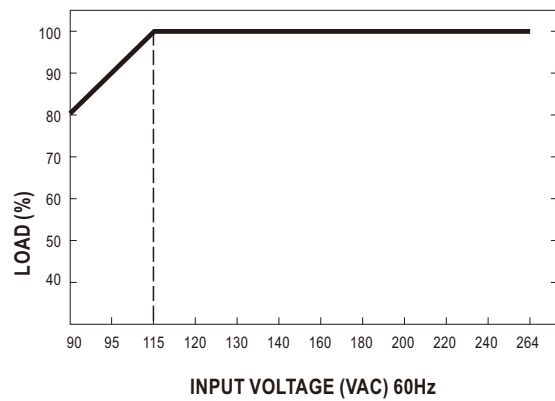

■ Mechanical Specification

Unit:mm

◎ RPS-300 (PCB type)

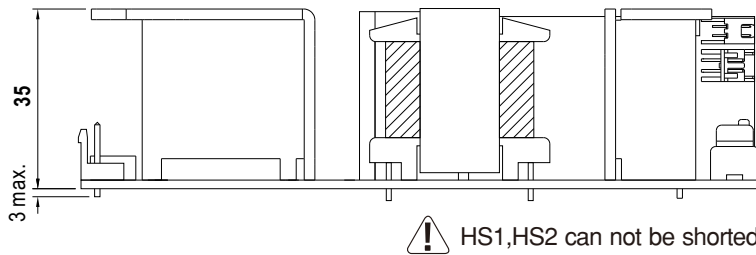
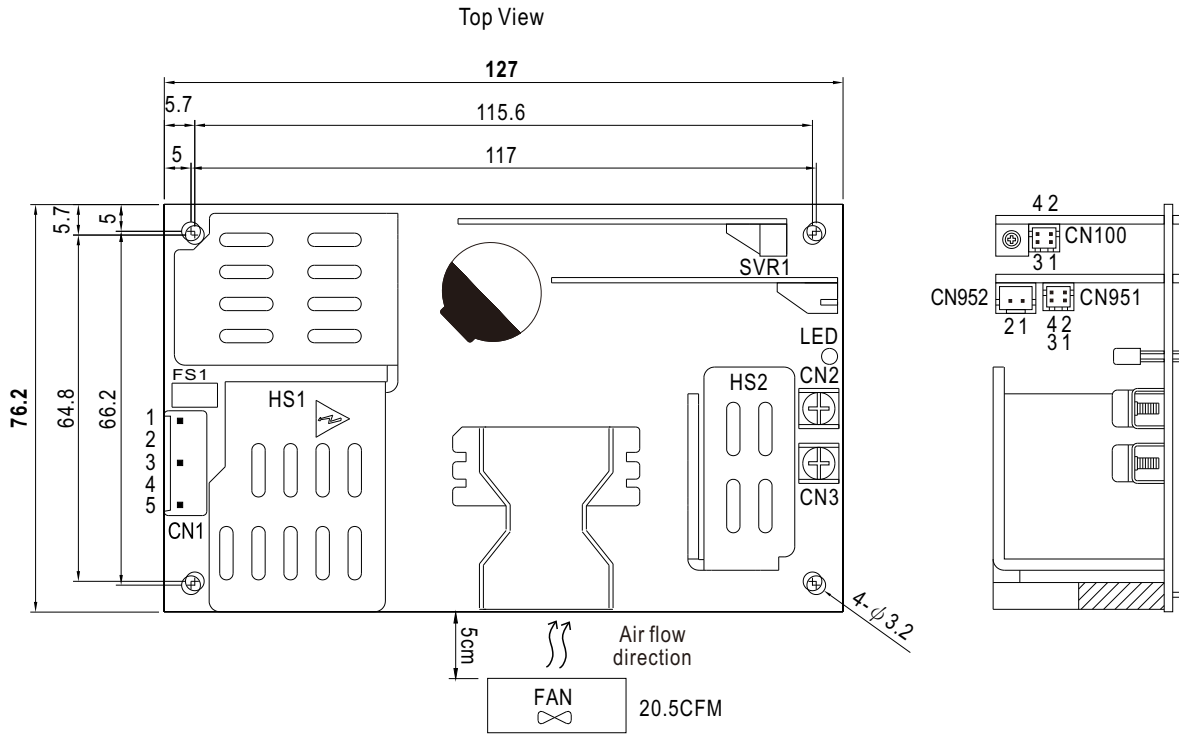

Side View

© RPS-300-C (Enclosed type)

Case No. 247A Unit:mm

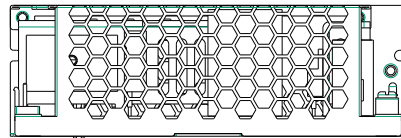

Side View

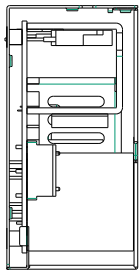
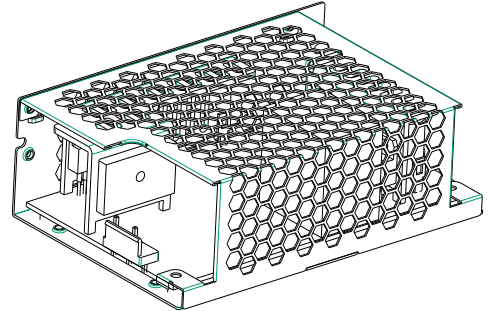

Side View

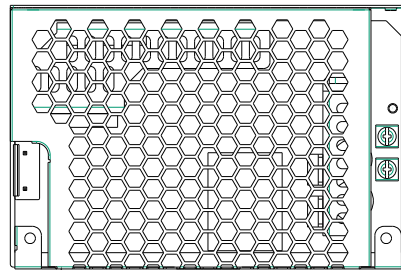

Top View

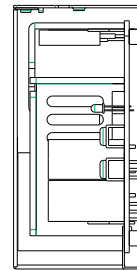

Side View

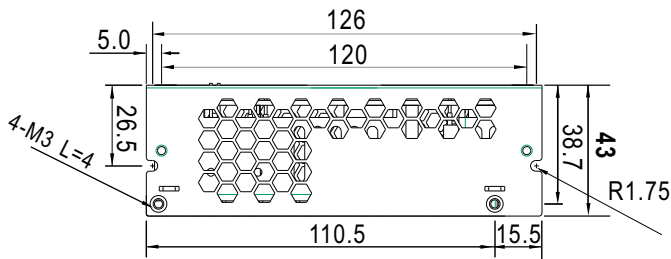
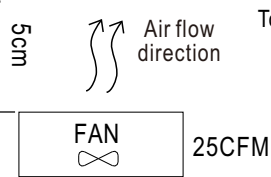

Side View

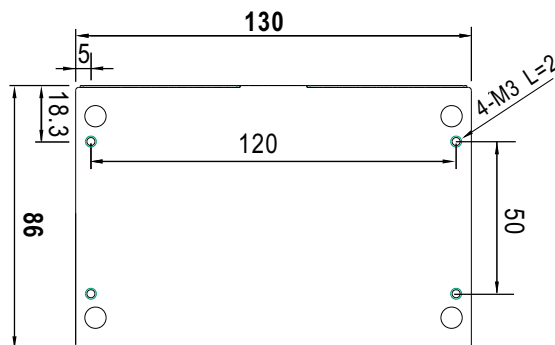

Bottom View

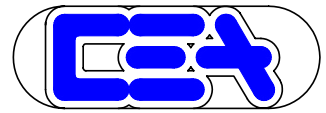

AC Input Connector (CN1) : JST B5P-VH or equivalent

Pin No.	Assignment	Mating Housing	Terminal
1	AC/N	JST VHR or equivalent	JST SVH-21T-P1.1 or equivalent
2,4	No Pin		
3	AC/L		
5	FG \perp		

Function Connector(CN100):HRS DF11-4DP-2DS or equivalent

Pin No.	Status	Mating Housing	Terminal
1	-S	HRS DF11-4DS or equivalent	HRS DF11-**SC or equivalent
2	+S		
3	DC COM		
4	PG		

DC Output Connector (CN2,CN3)

Pin No.	Assignment	Output Terminals
CN2	-V	M3.5 Pan HD screw in 2 positions Torque to 8 lbs-in(90cNm)max.
CN3	+V	

Function Connector(CN951):HRS DF11-4DP-2DS or equivalent

Pin No.	Status	Mating Housing	Terminal
1	5VSB	HRS DF11-4DS or equivalent	HRS DF11-**SC or equivalent
2,4	DC COM		
3	PS-ON		

 1.HS1,HS2 cannot be shorted.

FAN Connector(CN952) : JST S2B-XH or equivalent

Pin No.	Assignment	Mating Housing	Terminal
1	DC COM	JST XHP or equivalent	JST SXH-001T-P0.6 or equivalent
2	+12V		

- ※Note : 1. The FAN supply is designed to serve as the source of the additive external fan for the cooling of the power supply, enabling the full load delivery and assuring the best life span of the product. Please do not use this FAN supply to drive other devices.
- 2.The PCB type (Blank type) model delivers EMI Class B for both conducted emission and radiated emission for power supply , when configured into either Class I (with FG) .
- 3.The enclosed type(-C type) model is not suitable for configuration within a Class II (no FG) system but suggested within a Class I (with FG) system.

■ Installation Manual

Please refer to : <http://www.meanwell.com/manual.html>