

RPS-400 series



400W Reliable Green Medical Power Supply



ANSI/AAMI ES60601-1



EN60601-1



IEC60601-1



Features

- 5"x3" compact size
- Medical safety approved (2 x MOPP) according to ANSI/AAMI ES60601-1 and IEC/EN60601-1
- Suitable for BF application with appropriate system configuration
- 250W convection, 400W force air
- EMI Class B for Class I & Class A for Class II configuration
- No load power consumption < 0.5W by PS-ON control
- 5Vdc standby output, 12Vdc fan supply, Power Good, Power Fail and remote sense
- Protections: Short circuit / Overload / Over voltage / Over temperature
- 3 years warranty

Applications

- Oral irrigator
- Hemodialysis machine
- Medical computer monitors
- Sleep apnea devices
- Pump machine
- Electric bed

Description

RPS-400 is a 400W highly reliable green PCB type medical power supply with a high power density on the 5" by 3" footprint. It accepts 80~264VAC input and offers various output voltages between 12V and 48V. The working efficiency is up to 94% and the extremely low no load power consumption is down below 0.5W. RPS-400 is able to be used for both Class I (with FG) or Class II (no FG) system design. The extremely low leakage current is less than 160 μ A. In addition, it conforms to international medical regulations (2*MOPP) and EMC EN55011, perfectly fitting all kinds of BF rated "patient contact" medical system equipment. RPS-400 series also offers the enclosed style models (-C / TF / SF)

Model Encoding

RPS - 400 - 12 - C

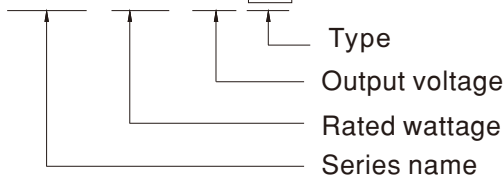

Type	Description	Note
Blank	PCB Type	In stock
C	Enclosed casing Type	In stock
TF	Enclosed Type with fan on the top	In stock
SF	Enclosed Type with fan on the side	In stock



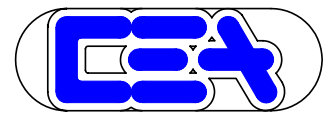

RPS-400 series



400W Reliable Green Medical Power Supply

SPECIFICATION

MODEL		RPS-400-12 □	RPS-400-15 □	RPS-400-18 □	RPS-400-24	RPS-400-27 □	RPS-400-36 □	RPS-400-48 □	
OUTPUT	DC VOLTAGE	12V	15V	18V	24V	27V	36V	48V	
	CURRENT	25CFM	33.3A	26.7A	22.3A	16.7A	14.9A	11.2A	8.4A
		Convection	20.8A	16.7A	13.9A	10.5A	9.3A	7A	5.3A
	RATED POWER	25CFM	399.6W	400.5W	401.4W	400.8W	402.3W	403.2W	403.2W
		Convection	249.6W	250.5W	250.2W	252W	251.1W	252W	254.4W
	RIPPLE & NOISE (max.) Note.2	120mVp-p	120mVp-p	150mVp-p	150mVp-p	200mVp-p	200mVp-p	200mVp-p	200mVp-p
	VOLTAGE ADJ. RANGE(main output)	11.4~12.6V	14.3~15.8V	17.1~18.9V	22.8~25.2V	25.6 ~ 28.4V	34.2 ~ 37.8V	45.6 ~ 50.4V	
	VOLTAGE TOLERANCE Note.3	±3.0%	±3.0%	±3.0%	±2.0%	±1.0%	±1.0%	±1.0%	±1.0%
	LINE REGULATION	±0.5%	±0.5%	±0.5%	±0.5%	±0.5%	±0.5%	±0.5%	±0.5%
	LOAD REGULATION	±1.0%	±1.0%	±1.0%	±1.0%	±1.0%	±1.0%	±1.0%	±1.0%
SETUP, RISE TIME	1000ms, 30ms/230VAC 1500ms, 30ms/115VAC at full load								
HOLD UP TIME (Typ.)	16ms/230VAC 16ms/115VAC at full load								
INPUT	VOLTAGE RANGE Note.4	80 ~ 264VAC		113 ~ 370VDC					
	FREQUENCY RANGE	47 ~ 63Hz							
	POWER FACTOR	PF>0.94/230VAC PF>0.98/115VAC at full load							
	EFFICIENCY (Typ.)	91.5%	92%	93%	93%	93.5%	94%	94%	
	AC CURRENT (Typ.)	4.2A/115VAC		2.1A/230VAC					
	INRUSH CURRENT (Typ.)	COLD START 35A/115VAC		70A/230VAC					
	LEAKAGE CURRENT (max.) Note.5	Earth leakage current <160μA/264VAC 50Hz , Touch current < 70μA/264VAC							
PROTECTION	OVERLOAD	105 ~ 135% rated output power Protection type : Hiccup mode, recovers automatically after fault condition is removed							
	OVER VOLTAGE	13.2 ~ 15.6V	16.5 ~ 19.5V	19.8 ~ 23.4V	26.4 ~ 31.2V	29.7 ~ 35.1V	39.6 ~ 46.8V	52.8 ~ 62.4V	
		Protection type : Shut down o/p voltage, re-power on to recover							
	OVER TEMPERATURE	Protection type : Shut down o/p voltage, recovers automatically after temperature goes down							
FUNCTION	5V STANDBY	5Vsb : 5V@0.6A without fan, 1A with fan 25CFM ; Tolerance ±2%, ripple : 120mVp-p(max.)							
	FAN SUPPLY	12V@0.5A for driving fan ; Tolerance ±10%							
	PS-ON INPUT SIGNAL	Power on: PS-ON = "Hi" or " > 2 ~ 5V" ; Power off: PS-ON = "Low" or " < 0 ~ 0.5V"							
	POWER GOOD / POWER FAIL	500ms>PG>10ms ; The TTL signal goes high with 10ms to 500ms delay after power set up ; The TTL signal goes low at least 1ms before Vo below 90% of rated value							
ENVIRONMENT	WORKING TEMP.	-30 ~ +70°C (Refer to "Derating Curve")							
	WORKING HUMIDITY	20 ~ 90% RH non-condensing							
	STORAGE TEMP., HUMIDITY	-40 ~ +85°C, 10 ~ 95% RH non-condensing							
	TEMP. COEFFICIENT	±0.03%/°C (0 ~ 50°C)							
	VIBRATION	10 ~ 500Hz, 2G 10min./1cycle, 60min. each along X, Y, Z axes							
	OPERATING ALTITUDE Note.6	4000 meters							

File Name:RPS-400-SPEC 2017-11-15



Note: all features are subject to change without notice.

SPECIFICATION

SAFETY & EMC (Note 7)	SAFETY STANDARDS	IEC60601-1, TUV EN60601-1, UL ANSI / AAMI ES60601-1 (3.1 version), CAN/CSA-C22.2 No. 60601-1:14 - Edition 3 approved; Design refer to EN60335-1				
	ISOLATION LEVEL	Primary-Secondary: 2xMOPP, Primary-Earth:1xMOPP, Secondary-Earth:1xMOPP				
	WITHSTAND VOLTAGE	I/P-O/P:4KVAC I/P-FG:2KVAC O/P-FG:1.5KVAC				
	ISOLATION RESISTANCE	I/P-O/P, I/P-FG:100M Ohms / 500VDC / 25°C / 70% RH				
	EMC EMISSION	Parameter	Standard			Test Level / Note
		Conducted emission	EN55011 (CISPR11)			Class B(Please see last page note1)
		Radiated emission	EN55011 (CISPR11)			Class B(Please see last page note1)
		Harmonic current	EN61000-3-2			Class A
		Voltage flicker	EN61000-3-3			-----
	EMC IMMUNITY	EN55024 , EN60601-1-2, EN61204-3				
Parameter		Standard			Test Level / Note	
ESD		EN61000-4-2			Level 4, 15KV air ; Level 4, 8KV contact	
RF field susceptibility		EN61000-4-3			Level 3, 10V/m(80MHz~2.7GHz) Table 9, 9~28V/m(385MHz~5.78GHz)	
EFT bursts		EN61000-4-4			Level 3, 2KV	
Surge susceptibility		EN61000-4-5			Level 4, 4KV/Line-FG ; 2KV/Line-Line	
Conducted susceptibility		EN61000-4-6			Level 3, 10V	
Magnetic field immunity		EN61000-4-8			Level 4, 30A/m	
Voltage dip, interruption		EN61000-4-11			100% dip 1 periods, 30% dip 25 periods, 100% interruptions 250 periods	
OTHERS	MTBF	194.1Khrs min. MIL-HDBK-217F (25°C)				
	DIMENSION	Type	RPS-400	RPS-400-C	RPS-400-TF	RPS-400-SF
		L*W*H	127*76.2*35mm 5"*3"*1.37"inch	130*86*43mm 5.11"*3.39"*1.69"inch	130*86*66.5mm 5.11"*3.39"*2.62"inch	160*86*43mm 6.3"*3.39"*1.69"inch
	PACKING	P.W.	0.39Kg	0.51Kg	0.58Kg	0.64Kg
		Q'TY	36pcs	24pcs	24pcs	24pcs
		G.W.	15Kg	13.2Kg	14.9Kg	16.4Kg
		M'MENT	1.03CUFT	0.77CUFT	0.86CUFT	0.91CUFT
NOTE	<p>1. All parameters NOT specially mentioned are measured at 230VAC input, rated load and 25 of ambient temperature.</p> <p>2. Ripple & noise are measured at 20MHz of bandwidth by using a 12" twisted pair-wire terminated with a 0.1µf & 47µf parallel capacitor.</p> <p>3. Tolerance : includes set up tolerance, line regulation and load regulation.</p> <p>4. Derating may be needed under low input voltages. Please check the derating curve for more details.</p> <p>5. Touch current was measured from primary input to DC output.</p> <p>6. The ambient temperature derating of 2.5°C / 1000m is needed for operating altitude greater than 2000m(6500ft).</p> <p>7. The power supply is considered a component which will be installed into a final equipment. All the Class I (with FG) EMC tests are executed by mounting the unit on a 360mm*360mm metal plate with 1mm of thickness. The Class II (without FG) EMC tests are executed by mounting the unit on a 130mm*86.6mm metal plate with 1mm of thickness. The final equipment must be re-confirmed that it still meets EMC directives. For guidance on how to perform these EMC tests, please refer to "EMI testing of component power supplies." (as available on http://www.meanwell.com)</p>					

■ Block Diagram

PFC fosc : 90KHz
PWM fosc : 100KHz

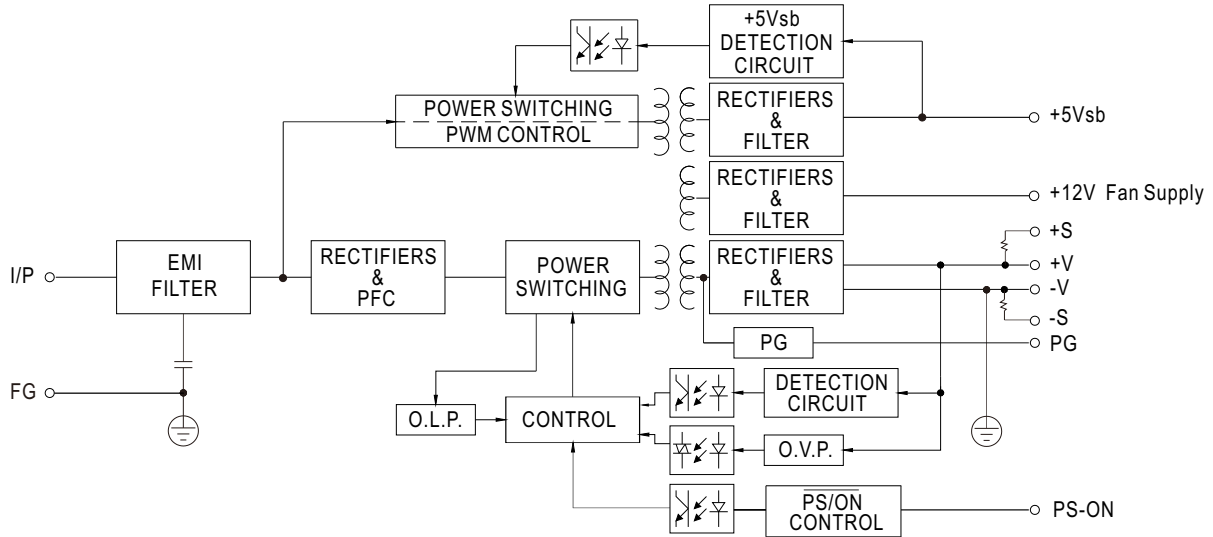

■ Output Derating vs Input Voltage

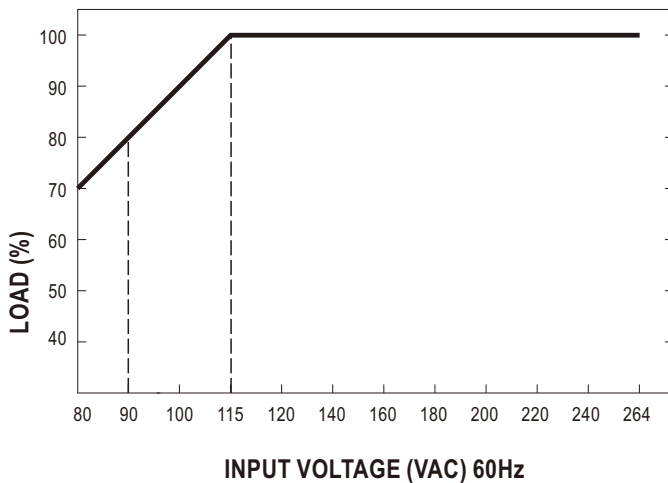



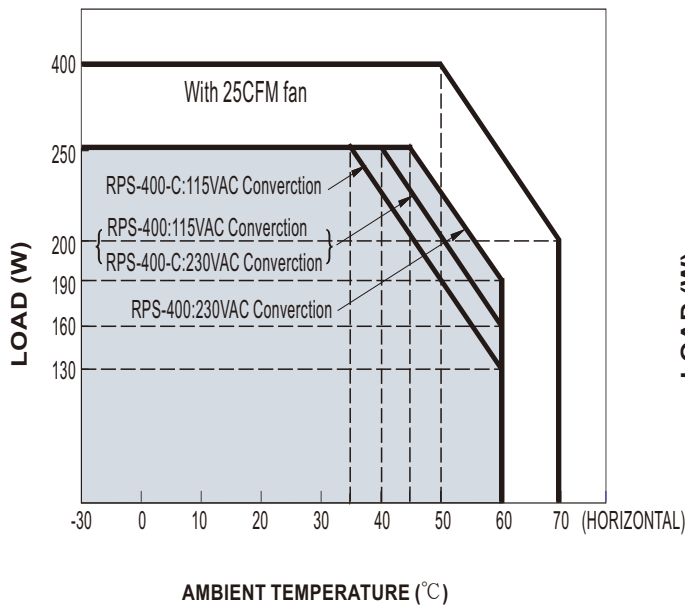

■ Derating Curve

○ RPS-400 & RPS-400-C

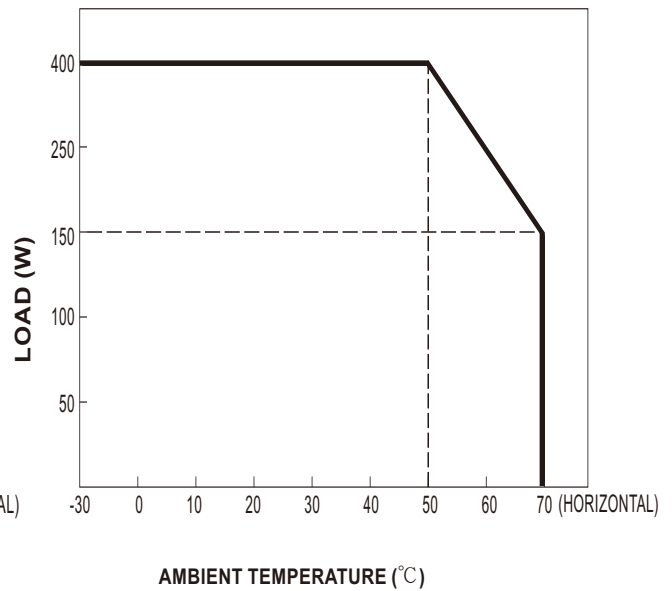

○ RPS-400-TF/SF



Order No.	RPS-400	RPS-400-C	RPS-400-TF	RPS-400-SF
Products				
Convection	250W	250W	---	---
Force Air	400W	400W	400W	400W

■ Mechanical Specification

● RPS-400 (PCB Type)

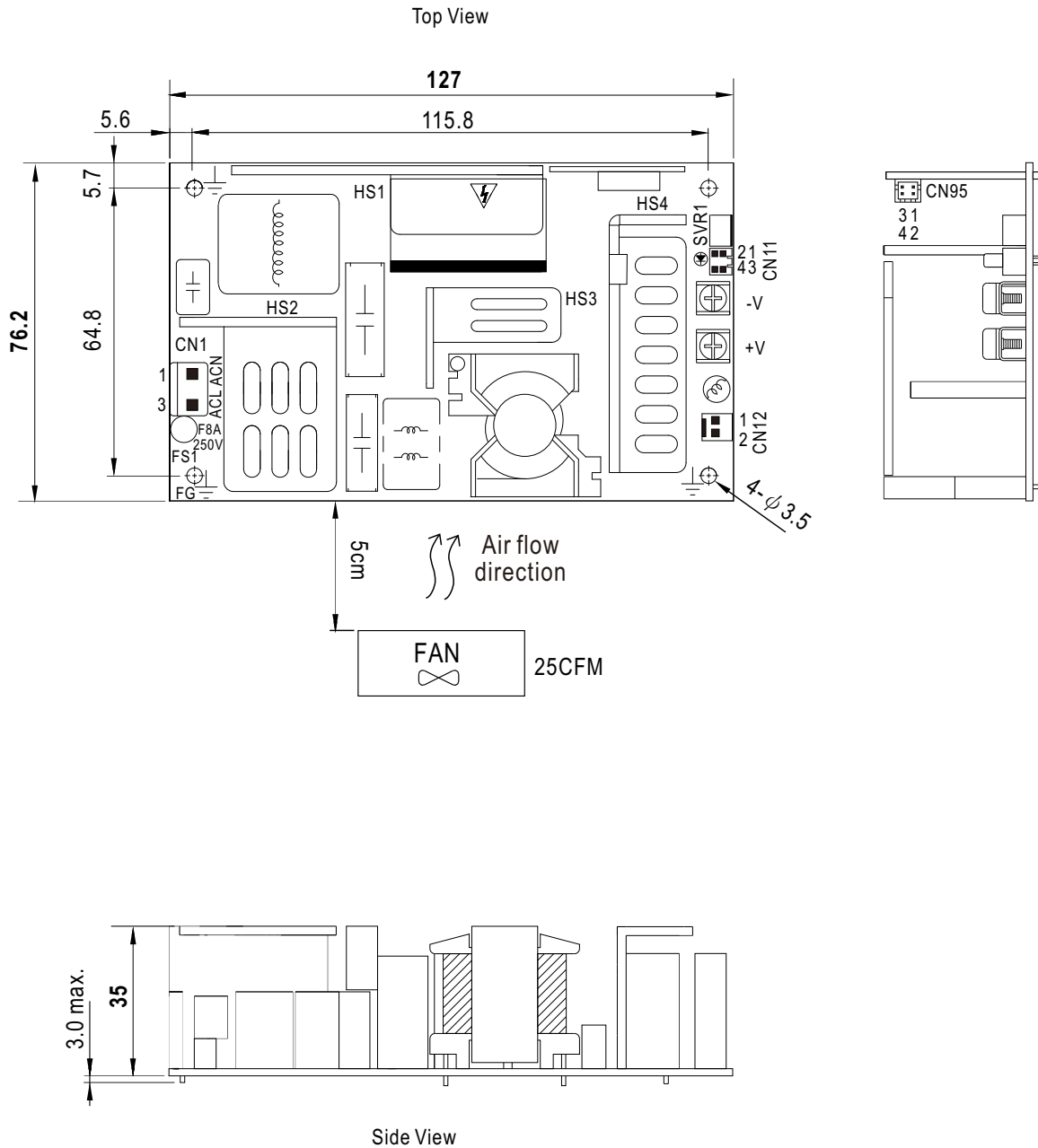

● RPS-400-C (Enclosed type)

Case No. 247A Unit:mm

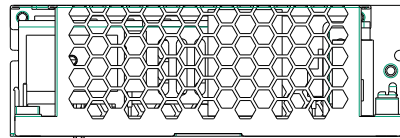

Side View

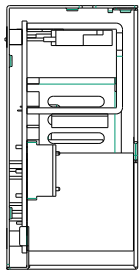
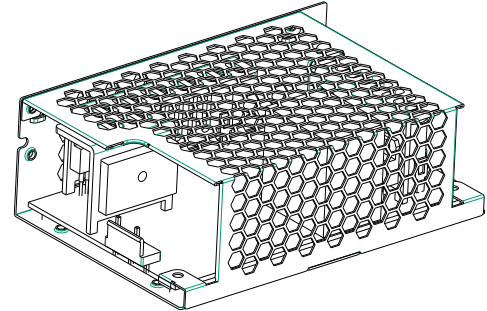

Side View

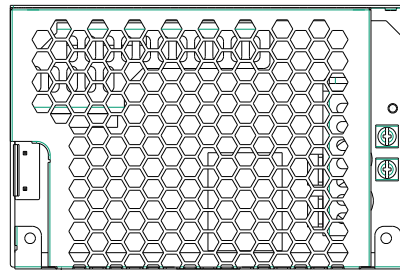

Top View

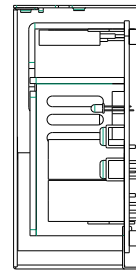

Side View

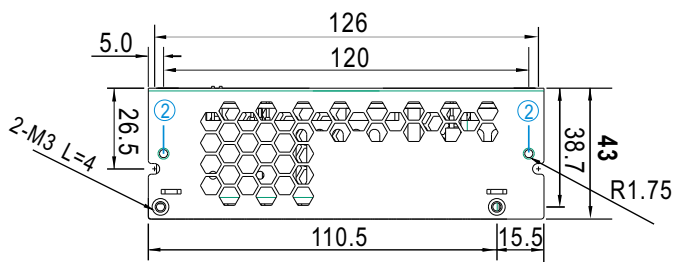
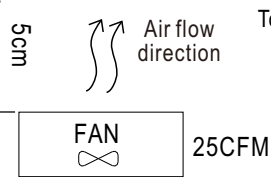

Side View

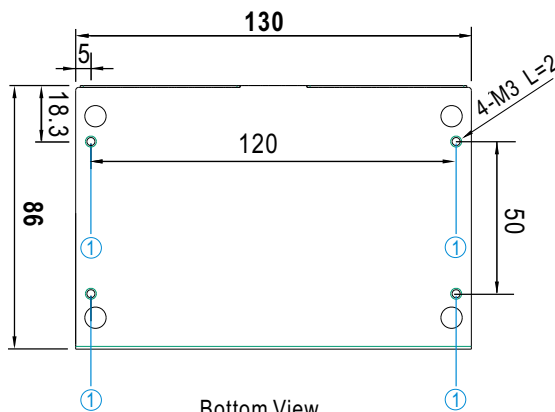

Bottom View

● RPS-400-TF (Enclosed type with fan on the top)

Case No. 247A-D 247B-T Unit:mm

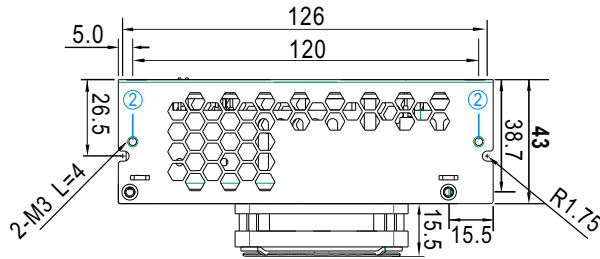

Side View

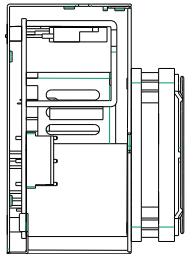
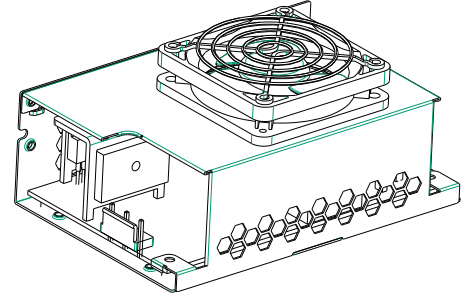

Side View

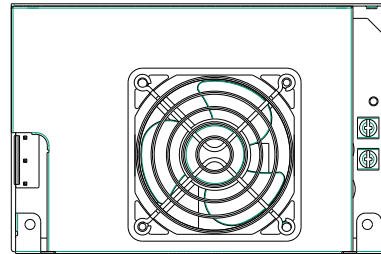

Top View

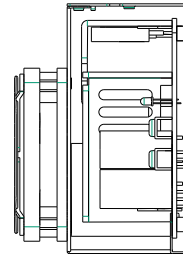

Side View

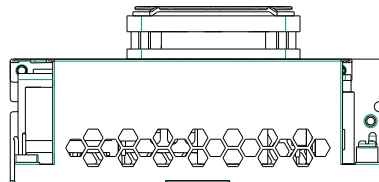

Side View

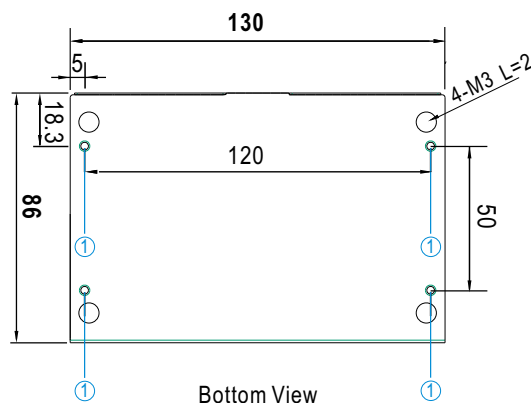

Bottom View

● RPS-400-SF (Enclosed type with fan on the side)

Case No. 248A Unit:mm

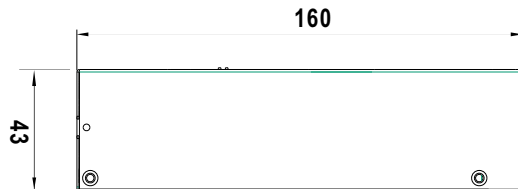

Side View

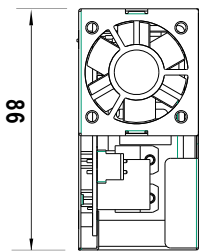
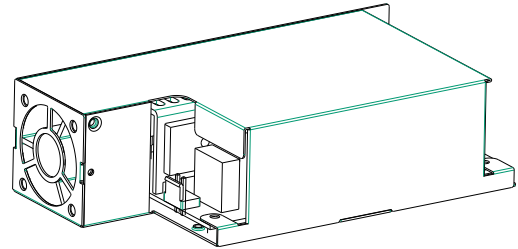

Side View

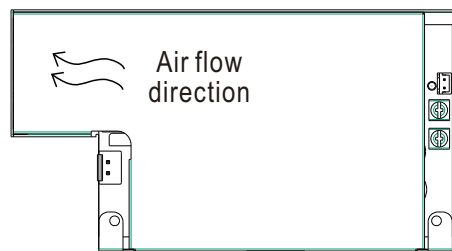

Top View

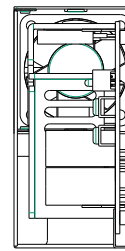

Side View

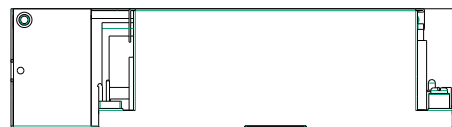

Side View

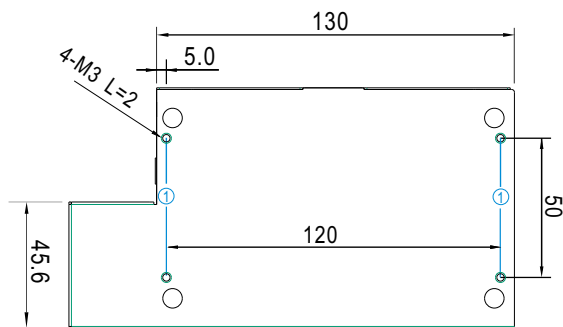

Bottom View

※ Mounting Instruction for -C/-TF/-SF Type

Hole No.	Recommended Screw Size	MAX. Penetration Depth L	Recommended mounting torque
①	M3	2mm	4~6Kgf-cm
②	M3	4mm	4~6Kgf-cm

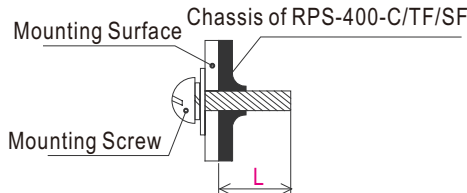

※ CONNECTION

AC Input Connector (CN1) : JST B3P-VH or equivalent

Pin No.	Assignment	Mating Housing	Terminal
1	AC/N	JST VHR or equivalent	JST SVH-21T-P1.1 or equivalent
2	No Pin		
3	AC/L		

Function Connector(CN11): TKP DH2I-2X2 or equivalent

Pin No.	Assignment	Mating Housing	Terminal
1	-S	TKP DH2 or equivalent	TKP or equivalent
2	+S		
3	DC COM		
4	PG		

DC Output Connector (CN2,CN3)

Pin No.	Assignment	Output Terminals
CN2	-V	M3.5 Pan HD screw in 2 positions Torque to 8 lbs-in(90cNm)max.
CN3	+V	

Function Connector(CN95): TKP DH2L-2X2 or equivalent

Pin No.	Assignment	Mating Housing	Terminal
1	5Vsb	TKP DH2 or equivalent	TKP or equivalent
2,4	DC COM		
3	PS-ON		

⚠ HS1,HS2,HS3,HS4 can not be shorted

FAN Connector(CN12) : TKP 8812-2 or equivalent
(Except for RPS-400-TF/SF)

Pin No.	Assignment	Mating Housing	Terminal
1	DC COM	TKP 2502 or equivalent	TKP 8811 or equivalent
2	+12V		

- ※ Note: 1. When the input voltage is 230VAC, the PCB type (Blank-Type) model delivers EMI Class B for both conducted emission and radiated emission for the power supply; When the input voltage is 110VAC, the PCB type (Blank Type) model delivers EMI Class B for conducted emission and Class A for radiated emission for the power supply. It delivers Class A for conducted emission and radiated emission, when configured into Class II (no FG) system.
2. The enclosed type (-C/TF/SF type) models are not suitable for configuration within a Class II (without FG) system, but suggested within a Class I (with FG) system.
3. Mounting Instruction for enclosed type.

■ Installation Manual

Please refer to : <http://www.meanwell.com/manual.html>