

## 200W Single Output DC-DC Converter

## SD-200 series



### ■ Features :

- 2:1 wide input range
- Protections: Short circuit / Overload / Over voltage / Over temperature
- 1500VAC I/O isolation
- Cooling by free air convection
- 100% full load burn-in test
- 24V and 48V input voltage design refer to LVD
- 2 years warranty

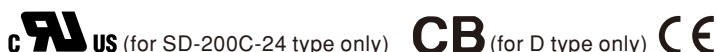

### SPECIFICATION

MODEL		SD-200B				SD-200C				
OUTPUT	DC VOLTAGE	5V	12V	24V	48V	5V	12V	24V	48V	
	RATED CURRENT	34A	16.7A	8.4A	4.2A	40A	16.7A	8.4A	4.2A	
	CURRENT RANGE	0 ~ 34A	0 ~ 16.7A	0 ~ 8.4A	0 ~ 4.2A	0 ~ 40A	0 ~ 16.7A	0 ~ 8.4A	0 ~ 4.2A	
	RATED POWER	170W	200.4W	201.6W	201.6W	200W	200.4W	201.6W	201.6W	
	RIPPLE & NOISE (max.) Note.2	100mVp-p	120mVp-p	150mVp-p	200mVp-p	100mVp-p	120mVp-p	150mVp-p	200mVp-p	
	VOLTAGE ADJ. RANGE	4.5 ~ 5.5VDC	11 ~ 16VDC	23 ~ 30VDC	43 ~ 53VDC	4.5 ~ 5.5VDC	11 ~ 16VDC	23 ~ 30VDC	43 ~ 53VDC	
	VOLTAGE TOLERANCE Note.3	±2.0%	±1.0%	±1.0%	±1.0%	±2.0%	±1.0%	±1.0%	±1.0%	
	LINE REGULATION	±0.5%	±0.5%	±0.5%	±0.5%	±0.5%	±0.5%	±0.5%	±0.5%	
	LOAD REGULATION	±1.0%	±1.0%	±1.0%	±1.0%	±1.0%	±1.0%	±1.0%	±1.0%	
SETUP, RISE TIME	300ms, 50ms at full load									
INPUT	VOLTAGE RANGE	B:19 ~ 36VDC		C:36 ~ 72VDC		D:72 ~ 144VDC				
	EFFICIENCY (Typ.)	79%	82%	85%	86%	81%	84%	86%	86%	
	DC CURRENT (Typ.)	10.8A/24V	10.6A/24V	10.4A/24V	10.4A/24V	5.4A/48V	5.2A/48V	6.7A/48V	5A/48V	
	INRUSH CURRENT (Typ.)	C:45A/48VDC		D:45A/96VDC						
PROTECTION	OVERLOAD	105 ~ 135% rated output power Protection type : Shut down o/p voltage, re-power on to recover								
	OVER VOLTAGE	5.75 ~ 6.75V	16.8 ~ 20V	31.5 ~ 37.5V	53 ~ 65V	5.75 ~ 6.75V	16.8 ~ 20V	31.5 ~ 37.5V	53 ~ 65V	
	OVER TEMPERATURE	Shut down o/p voltage, recovers automatically after temperature goes down								
ENVIRONMENT	WORKING TEMP.	-20 ~ +60°C (Refer to "Derating Curve")								
	WORKING HUMIDITY	20 ~ 90% RH non-condensing								
	STORAGE TEMP., HUMIDITY	-40 ~ +85°C, 10 ~ 95% RH								
	TEMP. COEFFICIENT	±0.03%/°C (0 ~ 50°C)								
	VIBRATION	10 ~ 500Hz, 2G 10min./1cycle, 60min. each along X, Y, Z axes								
SAFETY & EMC (Note 4)	SAFETY STANDARDS	UL60950-1 approved (for SD-200C-24 type only), IEC60950-1 CB approved by TUV (for D type only)								
	WITHSTAND VOLTAGE	I/P-O/P:1.5KVAC I/P-FG:2KVAC O/P-FG:0.5KVAC								
	ISOLATION RESISTANCE	I/P-O/P, I/P-FG, O/P-FG:100M Ohms / 500VDC / 25°C / 70% RH								
	EMC EMISSION	Compliance to EN55032 (CISPR32) Class B								
	EMC IMMUNITY	Compliance to EN61000-4-2,3,4,6,8, light industry level, criteria A								
OTHERS	MTBF	218.2K hrs min. MIL-HDBK-217F (25°C)								
	DIMENSION	215*115*50mm (L*W*H)								
	PACKING	1.1Kg; 12pcs/14.4Kg/0.92CUFT								
NOTE	<ol style="list-style-type: none"> <li>1. All parameters NOT specially mentioned are measured at 24,48,96VDC input, rated load and 25°C of ambient temperature.</li> <li>2. Ripple &amp; noise are measured at 20MHz of bandwidth by using a 12" twisted pair-wire terminated with a 0.1uf &amp; 47uf parallel capacitor.</li> <li>3. Tolerance : includes set up tolerance, line regulation and load regulation.</li> <li>4. The power supply is considered a component which will be installed into a final equipment. All the EMC tests are been executed by mounting the unit on a 360mm*360mm metal plate with 1mm of thickness. The final equipment must be re-confirmed that it still meets EMC directives. For guidance on how to perform these EMC tests, please refer to "EMI testing of component power supplies." (as available on <a href="http://www.meanwell.com">http://www.meanwell.com</a>)</li> </ol>									

File Name:SD-200-SPEC 2017-07-14



Note: all features are subject to change without notice.

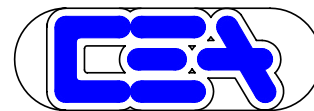

# SD-200 series



## 200W Single Output DC-DC Converter



### ■ Features :

- 2:1 wide input range
- Protections: Short circuit / Overload / Over voltage / Over temperature
- 1500VAC I/O isolation
- Cooling by free air convection
- 100% full load burn-in test
- 24V and 48V input voltage design refer to LVD
- 2 years warranty

**CB** (for D type only) **CE**

### SPECIFICATION

MODEL		SD-200D			
OUTPUT	DC VOLTAGE	5V	12V	24V	48V
	RATED CURRENT	40A	16.7A	8.4A	4.2A
	CURRENT RANGE	0 ~ 40A	0 ~ 16.7A	0 ~ 8.4A	0 ~ 4.2A
	RATED POWER	200W	200.4W	201.6W	201.6W
	RIPPLE & NOISE (max.) Note.2	100mVp-p	120mVp-p	150mVp-p	200mVp-p
	VOLTAGE ADJ. RANGE	4.5 ~ 5.5VDC	11 ~ 16VDC	23 ~ 30VDC	43 ~ 53VDC
	VOLTAGE TOLERANCE Note.3	±2.0%	±1.0%	±1.0%	±1.0%
	LINE REGULATION	±0.5%	±0.5%	±0.5%	±0.5%
	LOAD REGULATION	±1.0%	±1.0%	±1.0%	±1.0%
SETUP, RISE TIME	300ms, 50ms at full load				
INPUT	VOLTAGE RANGE	B:19 ~ 36VDC C:36 ~ 72VDC D:72 ~ 144VDC			
	EFFICIENCY (Typ.)	82%	82%	84%	90%
	DC CURRENT (Typ.)	3.5A/96V	3.5A/96V	3.5A/96V	3.5A/96V
	INRUSH CURRENT (Typ.)	C:45A/48VDC D:45A/96VDC			
PROTECTION	OVERLOAD	105 ~ 135% rated output power Protection type : Shut down o/p voltage, re-power on to recover			
	OVER VOLTAGE	5.75 ~ 6.75V	16.8 ~ 20V	31.5 ~ 37.5V	53 ~ 65V
	OVER TEMPERATURE	Shut down o/p voltage, recovers automatically after temperature goes down			
ENVIRONMENT	WORKING TEMP.	-20 ~ +60°C (Refer to "Derating Curve")			
	WORKING HUMIDITY	20 ~ 90% RH non-condensing			
	STORAGE TEMP., HUMIDITY	-40 ~ +85°C, 10 ~ 95% RH			
	TEMP. COEFFICIENT	±0.03%/°C (0 ~ 50°C)			
	VIBRATION	10 ~ 500Hz, 2G 10min./1cycle, 60min. each along X, Y, Z axes			
SAFETY & EMC (Note 4)	SAFETY STANDARDS	IEC60950-1 CB approved by TUV (for D type only)			
	WITHSTAND VOLTAGE	I/P-O/P:1.5KVAC I/P-FG:2KVAC O/P-FG:0.5KVAC			
	ISOLATION RESISTANCE	I/P-O/P, I/P-FG, O/P-FG:100M Ohms / 500VDC / 25°C / 70% RH			
	EMC EMISSION	Compliance to EN55022 (CISPR22) Class B			
	EMC IMMUNITY	Compliance to EN61000-4-2,3,4,6,8, light industry level, criteria A			
OTHERS	MTBF	218.2K hrs min. MIL-HDBK-217F (25°C)			
	DIMENSION	215*115*50mm (L*W*H)			
	PACKING	1.1Kg; 12pcs/14.4Kg/0.92CUFT			
NOTE	<p>1. All parameters NOT specially mentioned are measured at 24,48,96VDC input, rated load and 25°C of ambient temperature.</p> <p>2. Ripple &amp; noise are measured at 20MHz of bandwidth by using a 12" twisted pair-wire terminated with a 0.1uf &amp; 47uf parallel capacitor.</p> <p>3. Tolerance : includes set up tolerance, line regulation and load regulation.</p> <p>4. The power supply is considered a component which will be installed into a final equipment. All the EMC tests are been executed by mounting the unit on a 360mm*360mm metal plate with 1mm of thickness. The final equipment must be re-confirmed that it still meets EMC directives. For guidance on how to perform these EMC tests, please refer to "EMI testing of component power supplies." (as available on <a href="http://www.meanwell.com">http://www.meanwell.com</a>)</p>				

File Name:SD-200-SPEC 2017-07-14



Note: all features are subject to change without notice.

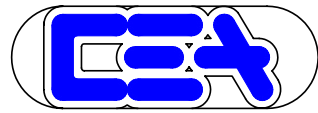

200W Single Output DC-DC Converter

**SD-200** series

**Mechanical Specification**

Case No. 912H Unit:mm

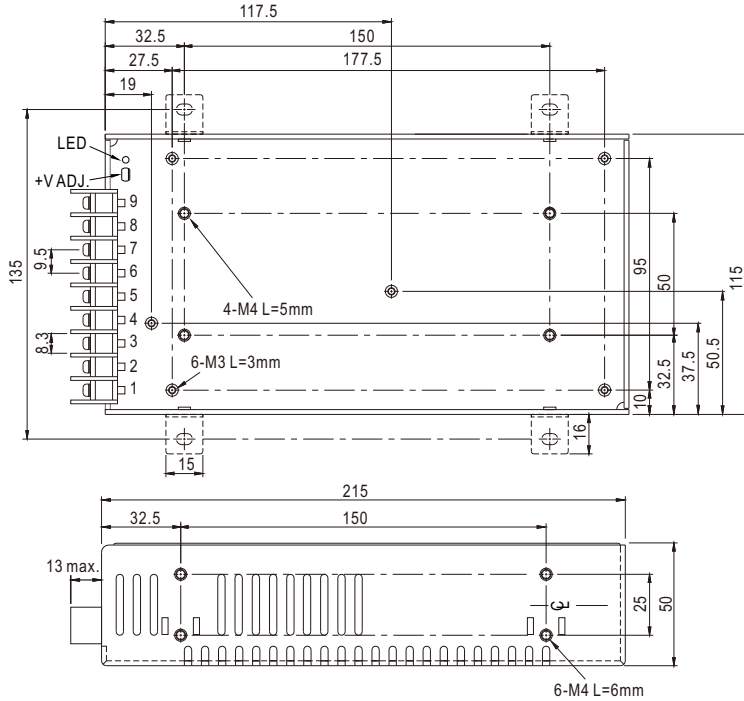

Terminal Pin No. Assignment :

Pin No.	Assignment	Pin No.	Assignment
1	DC INPUT V+	4,5,6	DC OUTPUT V-
2	DC INPUT V-	7,8,9	DC OUTPUT V+
3	FG $\perp$		

**Block Diagram**

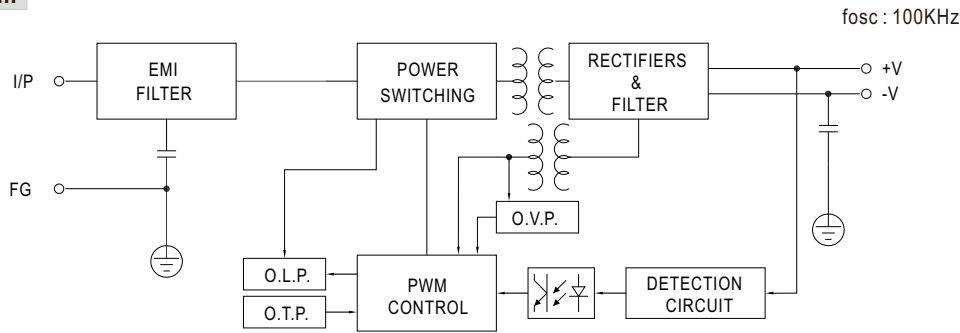

**Derating Curve**

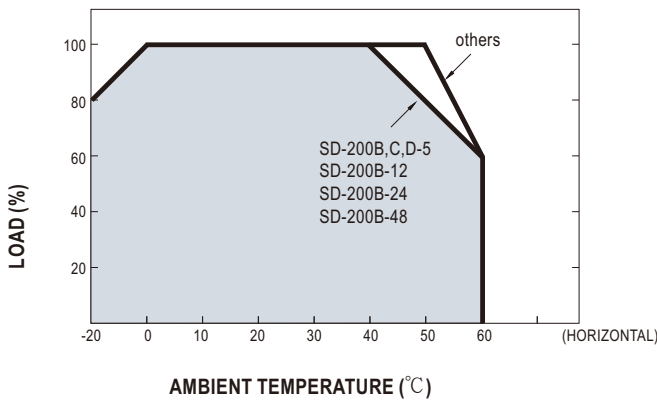

**Static Characteristics**

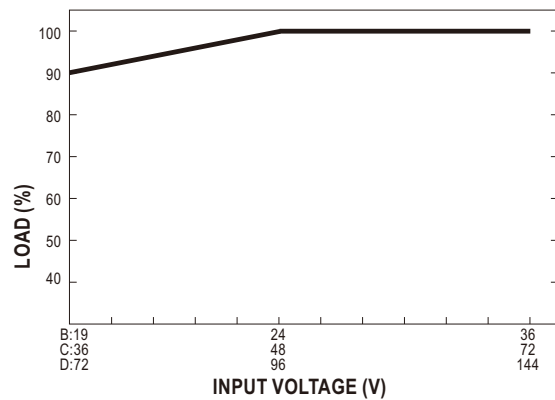

File Name:SD-200-SPEC 2017-07-14



Note: all features are subject to change without notice.