



■ Features :

- High efficiency 91% and low power dissipation
- 150% peak load capability
- Built-in active PFC function, PF>0.93
- Protections: Short circuit / Overload / Over voltage / Over temperature
- Cooling by free air convection
- Can be installed on DIN rail TS-35/7.5 or 15
- UL 508 (industrial control equipment) approved
- EN61000-6-2(EN50082-2) industrial immunity level
- Built-in DC OK relay contact
- 100% full load burn-in test
- 3 years warranty



SPECIFICATION

MODEL		SDR-120-12	SDR-120-24	SDR-120-48
OUTPUT	DC VOLTAGE	12V	24V	48V
	RATED CURRENT	10A	5A	2.5A
	CURRENT RANGE	0 ~ 10A	0 ~ 5A	0 ~ 2.5A
	RATED POWER	120W	120W	120W
	PEAK CURRENT	15A	7.5A	3.75A
	PEAK POWER <small>Note.6</small>	180W (3 sec.)		
	RIPPLE & NOISE (max.) <small>Note.2</small>	100mVp-p	100mVp-p	120mVp-p
	VOLTAGE ADJ. RANGE	12 ~ 14V	24 ~ 28V	48 ~ 55V
	VOLTAGE TOLERANCE <small>Note.3</small>	± 1.0%	± 1.0%	± 1.0%
	LINE REGULATION	± 0.5%	± 0.5%	± 0.5%
	LOAD REGULATION	± 1.0%	± 1.0%	± 1.0%
	SETUP, RISE TIME	1500ms, 60ms/230VAC 3000ms, 60ms/115VAC at full load		
HOLD UP TIME (Typ.)	20ms/230VAC 20ms/115VAC at full load			
INPUT	VOLTAGE RANGE <small>Note.7</small>	88 ~ 264VAC	124 ~ 370VDC	
	FREQUENCY RANGE	47 ~ 63Hz		
	POWER FACTOR (Typ.)	0.93/230VAC	0.96/115VAC at full load	
	EFFICIENCY (Typ.)	89%	91%	90.5%
	AC CURRENT (Typ.)	1.4A/115VAC	0.7A/230VAC	
	INRUSH CURRENT (Typ.)	35A/115VAC	70A/230VAC	
LEAKAGE CURRENT	<1mA / 240VAC			
PROTECTION	OVERLOAD	Normally works within 110 ~ 150% rated output power for more than 3 seconds and then shut down o/p voltage >150% rated power, constant current limiting with auto-recovery within 3 seconds and shut down o/p voltage after 3 seconds		
	OVER VOLTAGE	14 ~ 17V	29 ~ 33V	56 ~ 65V
	OVER TEMPERATURE	95°C ± 5°C (TSW) detect on heatsink of power switch Protection type : Shut down o/p voltage, re-powers on to recover		
FUNCTION	DC OK REALY CONTACT RATINGS (max.)	60Vdc/0.3A, 30Vdc/1A, 30Vac/0.5A resistive load		
	WORKING TEMP.	-25 ~ +70°C (Refer to "Derating Curve")		
ENVIRONMENT	WORKING HUMIDITY	20 ~ 95% RH non-condensing		
	STORAGE TEMP., HUMIDITY	-40 ~ +85°C, 10 ~ 95% RH		
	TEMP. COEFFICIENT	± 0.03%/°C (0 ~ 50°C)		
	VIBRATION	Component: 10 ~ 500Hz, 2G 10min./1cycle, 60min. each along X, Y, Z axes; Mounting: Compliance to IEC60068-2-6		
	SAFETY & EMC <small>(Note 4)</small>	SAFETY STANDARDS	UI508, TUV EN60950-1 approved; (meet EN60204-1)	
WITHSTAND VOLTAGE		I/P-O/P:3KVAC I/P-FG:2KVAC O/P-FG:0.5KVAC O/P-DC OK:0.5KVAC		
ISOLATION RESISTANCE		I/P-O/P, I/P-FG, O/P-FG:>100M Ohms / 500VDC / 25°C / 70% RH		
EMC EMISSION		Compliance to EN55011, EN55032 (CISPR32), EN61204-3 Class B, EN61000-3-2,-3		
EMC IMMUNITY		Compliance to EN61000-4-2,3,4,5,6,8,11, EN55024, EN61000-6-2 (EN50082-2), EN61204-3, heavy industry level, criteria A, SEMI F47, GL approved		
OTHERS	MTBF	289.9K hrs min. MIL-HDBK-217F (25°C)		
	DIMENSION	40*125.2*113.5mm (W*H*D)		
	PACKING	0.67Kg; 20pcs/14.4Kg/1.16CUFT		
NOTE	<ol style="list-style-type: none"> 1. All parameters NOT specially mentioned are measured at 230VAC input, rated load and 25°C of ambient temperature. 2. Ripple & noise are measured at 20MHz of bandwidth by using a 12" twisted pair-wire terminated with a 0.1uf & 47uf parallel capacitor. 3. Tolerance : includes set up tolerance, line regulation and load regulation. 4. The power supply is considered a component which will be installed into a final equipment. The final equipment must be re-confirmed that it still meets EMC directives. 5. Installation clearances : 40mm on top, 20mm on the bottom, 5mm on the left and right side are recommended when loaded permanently with full power. In case the adjacent device is a heat source, 15mm clearance is recommended. 6. 3 seconds max., please refer to peak loading curves. 7. Derating may be needed under low input voltage. Please check the derating curve for more details. 			

Mechanical Specification

Case No.992A Unit:mm

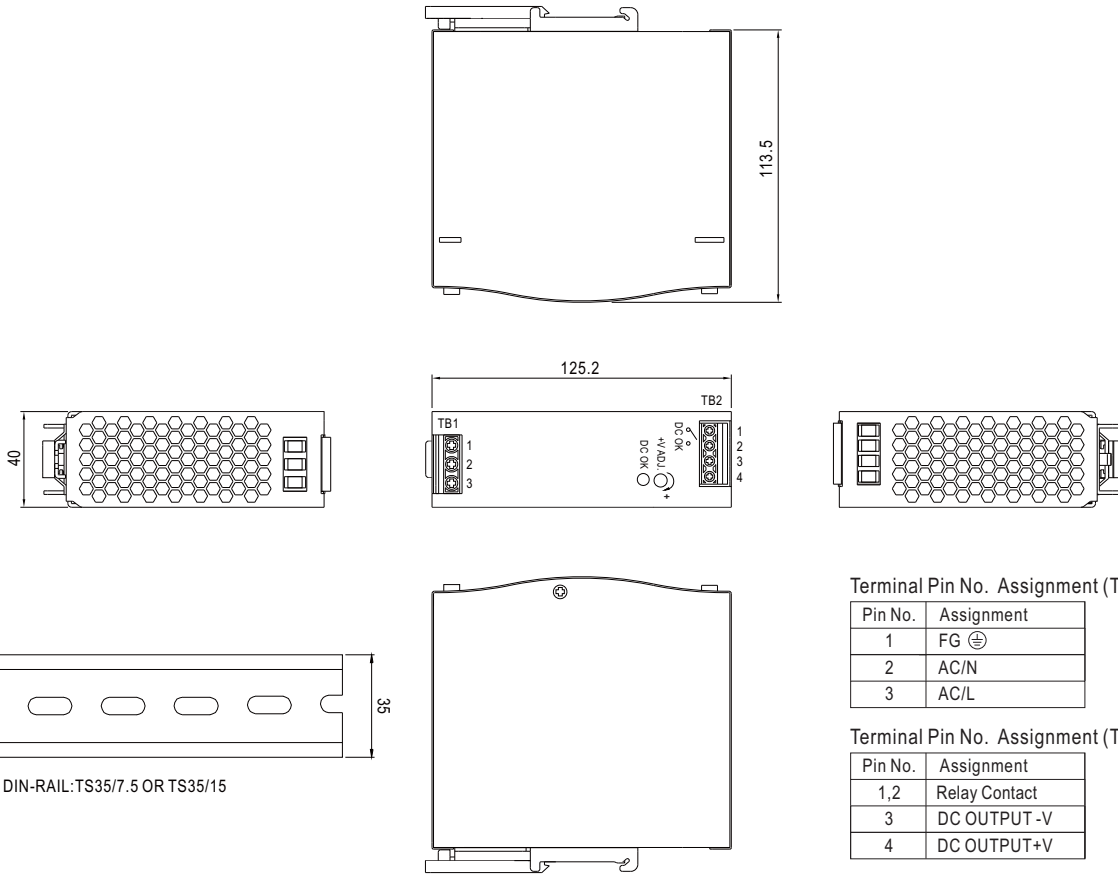

Block Diagram

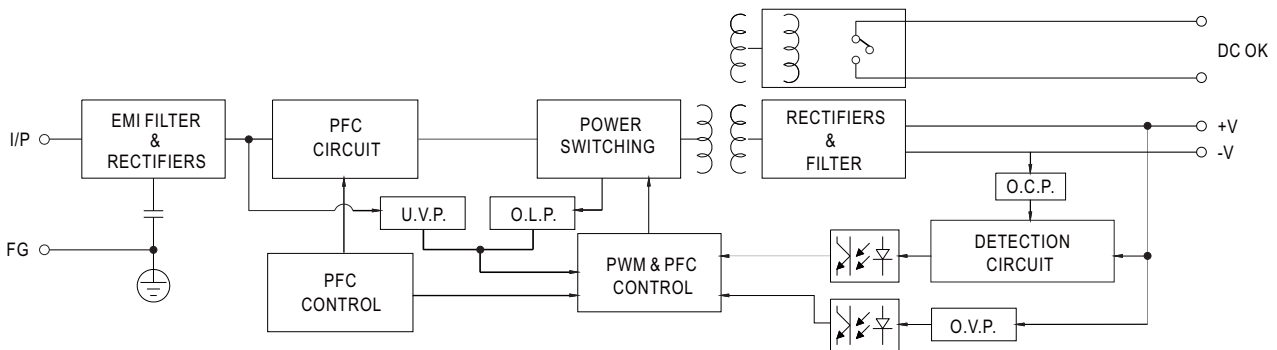

DC OK Relay Contact

Contact Close	PSU turns on / DC OK.
Contact Open	PSU turns off / DC Fail.
Contact Ratings (max.)	30V/1A resistive load.

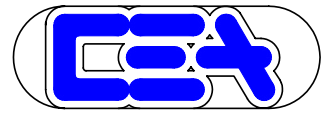

120W Single Output Industrial DIN RAIL with PFC Function

SDR-120 series

■ Peak Loading

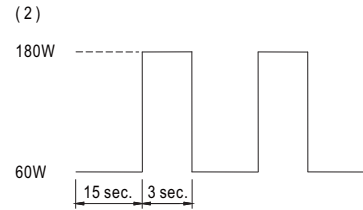
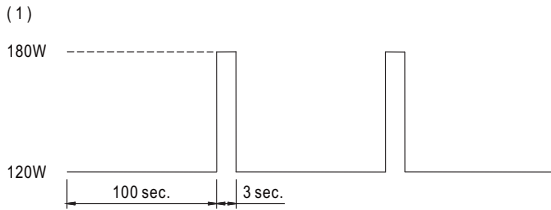

■ Derating Curve

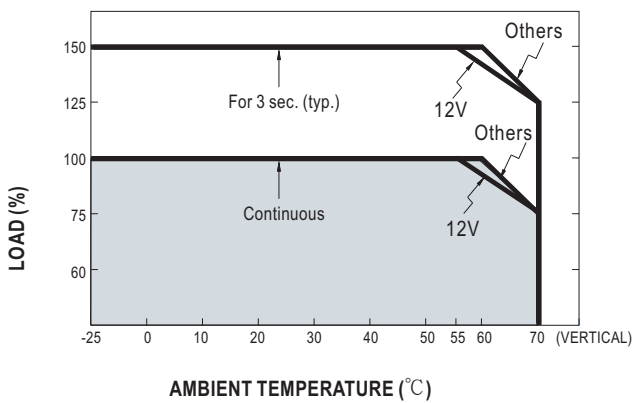

■ Output derating VS input voltage

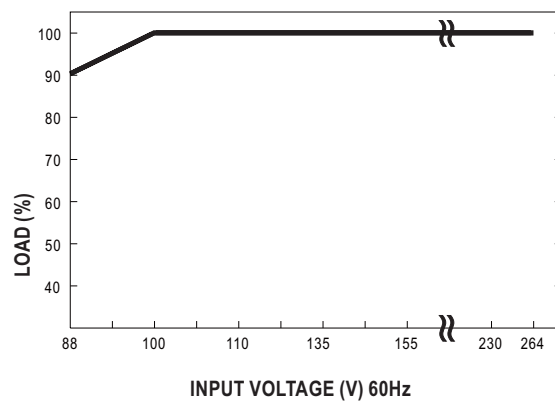

File Name:SDR-120-SPEC 2017-07-07



Note: all features are subject to change without notice.