



■ Features :

- True sine wave output (THD<3%)
- High surge power up to 6000W
- U.P.S. mode and energy saving mode (selectable)
- High efficiency up to 92%
- Power ON-OFF switch
- Standby saving mode can be selectable
- Front panel indicator for operation status
- Thermostatically controlled cooling fan
- Protections: Bat. low alarm / Bat. low shutdown / Over voltage / Over temp. / Output short / Input polarity reverse / Overload / AC circuit breaker
- Application : Home appliance, power tools, office and portable equipment, vehicle and yacht ...etc.
- Built-in solar / AC charger
- Computer-based monitoring software (Note.7)
- 3 years warranty



SPECIFICATION

| MODEL | TN-3000-112□ | TN-3000-124□ | TN-3000-148□ | TN-3000-212□ | TN-3000-224□ | TN-3000-248□ |
|---|--|--------------|---|---|--------------|--------------|
| OUTPUT | RATED POWER (Typ.) 3000W | | | | | |
| | MAXIMUM OUTPUT POWER (Typ.) 3450W for 180 sec. / 4500W for 10 sec. / surge power 6000W for 30 cycles | | | | | |
| | AC VOLTAGE | | | AC VOLTAGE | | |
| | Factory setting set at 110VAC | | | Factory setting set at 230VAC | | |
| | 100 / 110 / 115 / 120VAC selectable by setting button S.W | | | 200 / 220 / 230 / 240VAC selectable by setting button S.W | | |
| | FREQUENCY 60±0.1Hz 50/60Hz selectable by setting button S.W | | | | | |
| | WAVEFORM Note.8 True sine wave (THD<3%) | | | | | |
| | AC REGULATION (Typ.) ±3% | | | | | |
| TRANSFER TIME (Typ.) 10ms inverter→→by pass | | | | | | |
| SAVING MODE (Typ.) Default disabled. Load ≤5W will be changed to standby mode | | | | | | |
| FRONT PANEL INDICATOR Battery voltage level, output load level, saving mode, fault and operation status | | | | | | |
| INPUT | BAT. VOLTAGE 12V 24V 48V 12V 24V 48V | | | | | |
| | VOLTAGE RANGE (Typ.) Note.3,6 10.5 ~ 15VDC 21 ~ 30VDC 42 ~ 60VDC 10.5 ~ 15VDC 21 ~ 30VDC 42 ~ 60VDC | | | | | |
| | DC CURRENT (Typ.) Note.4 300A 150A 75A 300A 150A 75A | | | | | |
| | NO LOAD DISSIPATION (Typ.) ≤ 10W @ standby saving mode | | | | | |
| | OFF MODE CURRENT DRAW (Typ.) ≤ 1mA | | | | | |
| | EFFICIENCY (Typ.) Note.1 88% 90% 91% 89% 91% 92% | | | | | |
| BATTERY TYPES Open & sealed lead acid battery | | | | | | |
| BATTERY INPUT PROTECTION | FUSE 40A*12 40A*6 20A*6 40A*12 40A*6 20A*6 | | | | | |
| | BAT. LOW ALARM Note.6 11.3V 22.5V 45V 11.3V 22.5V 45V | | | | | |
| | BAT. LOW SHUTDOWN Note.6 10.5V 21V 42V 10.5V 21V 42V | | | | | |
| | REVERSE POLARITY By internal fuse open | | | | | |
| OUTPUT PROTECTION | OVER TEMPERATURE 90°C ± 5°C 85°C ± 5°C 85°C ± 5°C 80°C ± 5°C 75°C ± 5°C 75°C ± 5°C | | | | | |
| | Protection type : Shut down o/p voltage, re-power on to recover | | | | | |
| | OUTPUT SHORT Protection type : Shut down o/p voltage, re-power on to recover | | | | | |
| | OVER LOAD (Typ.) 105 ~ 115% load for 180 sec., 115% ~ 150% load for 10 sec. | | | | | |
| | Protection type : Shut down o/p voltage, re-power on to recover | | | | | |
| CIRCUIT BREAKER | | | CIRCUIT BREAKER | | | |
| AC output: 40A, AC receptacle: 15A | | | AC output: 20A, AC receptacle: 15A | | | |
| GFCI PROTECTION Optional (Only type F) None | | | | | | |
| ENVIRONMENT | WORKING TEMP. Note.2 0 ~ +40°C @ 100% load ; 60°C @ 50% load | | | | | |
| | WORKING HUMIDITY 20% ~ 90% RH non-condensing | | | | | |
| | STORAGE TEMP., HUMIDITY -30 ~ +70°C / -22 ~ +158°F, 10 ~ 95% RH non-condensing | | | | | |
| | VIBRATION 10 ~ 500Hz, 3G 10min./1cycle, 60min. each along X, Y, Z axes | | | | | |
| SAFETY & EMC | SAFETY STANDARDS | | | SAFETY STANDARDS | | |
| | UL458 (only for Type G) | | | None | | |
| | LVD | | | EN60950-1 | | |
| | WITHSTAND VOLTAGE Bat I/P - AC I/P:3.0KVAC Bat I/P - AC O/P:3.0KVAC AC O/P - FG:1.5KVAC | | | | | |
| | ISOLATION RESISTANCE Bat I/P - AC O/P, Bat I/P - FG, AC O/P - FG: 100M ohms / 500VDC / 25°C / 70% RH | | | | | |
| EMC EMISSION | | | EMC EMISSION | | | |
| Compliance to FCC class A | | | Compliance to EN55032 class A, 72/ 245/ CEE, 95/ 54/ CE, E-Mark | | | |
| EMC IMMUNITY None Compliance to EN61000-4-2,3,4,5,6,8,11 | | | | | | |
| AC CHARGER | CHARGE CURRENT (Typ.) 25A 12A 6A 25A 12A 6A | | | | | |
| | CHARGE VOLTAGE Note.6 14.3V 28.5V 57V 14.3V 28.5V 57V | | | | | |
| SOLAR PANEL | MAX OPEN CIRCUIT VOLTAGE 25V 45V 75V 25V 45V 75V | | | | | |
| | SHORT CIRCUIT CURRENT (max.) 30A | | | | | |
| OTHERS | CONTROL WIRING Note.7 RJ11 -RS232 | | | | | |
| | DIMENSION 466.8*283.5*100mm (L*W*H) | | | | | |
| | PACKING 12.9Kg; 1pcs/14Kg/1.49CUFT | | | | | |
| NOTE | <p>1.Efficiency is tested by 2100W, linear load at 13V, 26V, 52V input voltage.</p> <p>2.Output derating capacity referenced by curve 1.</p> <p>3.Input derating capacity referenced by curve 2.</p> <p>4.DC current is tested by 3000W, linear load at 12V, 24V, 48V input voltage.</p> <p>5.All parameters not specified above are measured at rated load, 25°C of ambient temperature and set to factory setting.</p> <p>6.The tolerance of each voltage value by models is:112/212→±0.5V;124/224→±1V;148/248→±2V.</p> <p>7.The cable is enclosed for the connection between TN-3000 and computer for software monitoring.</p> <p>8.TH.D is tested by 3000W, linear load at 13,26,52V input voltage.</p> <p>9.Please do not turn on the inverter before start the engine if inverter connect to vehicle's battery directly.</p> | | | | | |

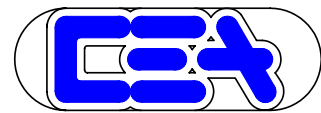

■ Instructions for TN-3000 monitoring software

1. The monitoring software can be downloaded from product section (with TN-3000 specification) on MEAN WELL's official website, <http://www.meanwell.com>
2. The monitoring software can run on Windows 7 English version, Windows 7 Chinese (Traditional, Taiwan) version, Windows 8 English version and Windows 8 Chinese (Traditional, Taiwan) version
3. Installation of TN-3000 unit and PC

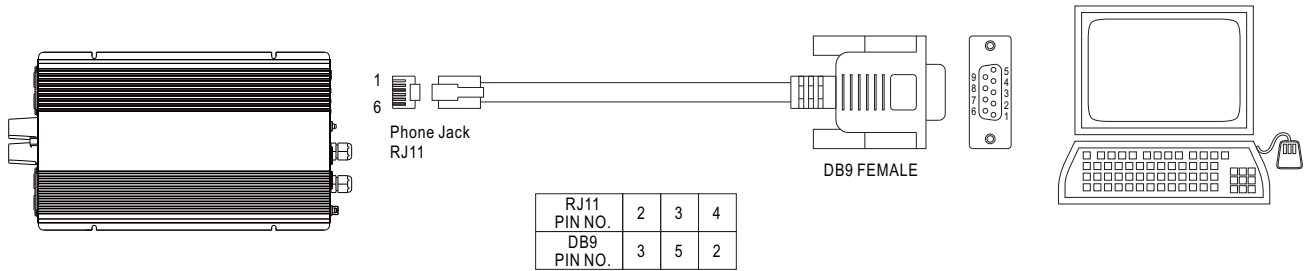

Figure 1

4. Explanation of Monitoring Manu

4.1 Main Page

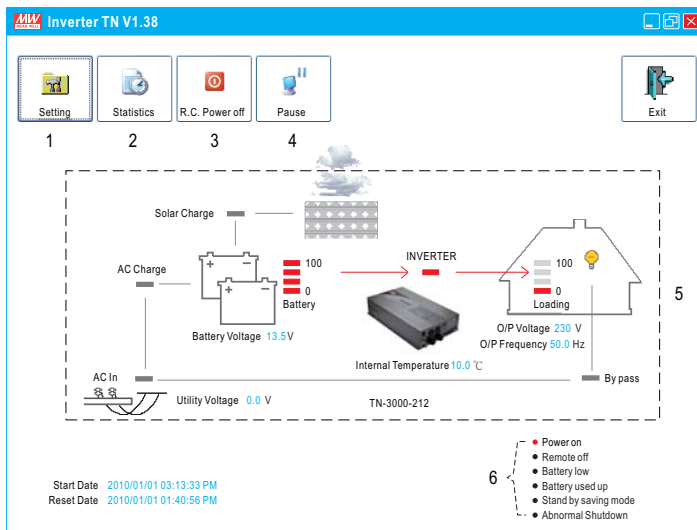
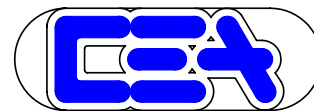

Figure 2

1. Setting: Adjustment for output voltage, charging related voltage, frequency, and operation mode. Please refer to Figure 3 for details.
2. Statistics: Calculate for the percentage of operating period for each operation mode. Please refer to Figure 4 for details.
3. R.C. Power off: Power can be turned ON or OFF at the remote location.
4. Pause: Stop refreshing the page of monitoring software.
5. Status of unit: Indicating current operating status of TN-3000.
6. Signals that display current condition of the unit.



4.2 Setting Page

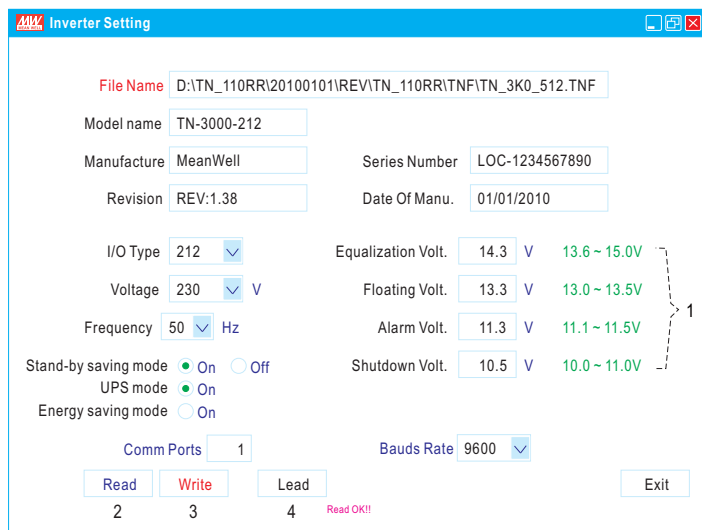

Figure 3

1. User can adjust the settings based on the characteristics of batteries been used: Equalization Voltage, Floating Voltage, Alarm Voltage, and Shut-down Voltage. UPS Mode / Energy Saving Mode selection and AC output voltage and frequency can also be set in this page.
2. Read: Read current settings of the unit.
3. Write: Write the revised setting into the unit.
4. Load: Load in factory default settings.

4.3 Statistic Page

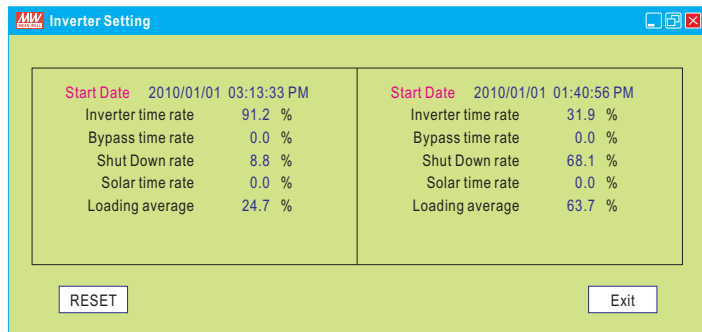
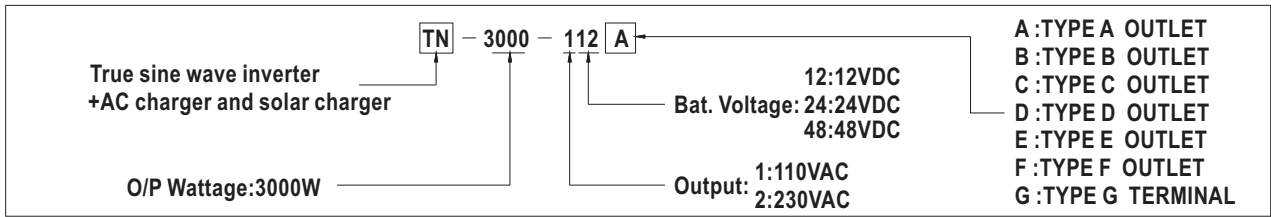

Figure 4

1. Start Date: Date that installing the monitoring software.
2. Reset Date: Date that resetting the statistics. The Start Date will not be influenced by resetting the statistics or turning off the unit.
3. Inverter time rate: Operating period of "Inverter Mode" represents how many percent of the whole operating period.
4. Bypass time rate: Operating period of "Bypass Mode" (energy provides directly by the utility) represents how many percent of the whole operating period.
5. Shut down rate: Percentage of time period that the unit is under the condition of shut down.
* **Inverter time rate + Bypass time rate + Shut down rate = 100%**
6. Solar time rate: Percentage of time period that the solar charger is functioning after turning on the TN-3000 unit.
7. Loading average: Average loading after turning on the TN-3000 unit.





AC Output Receptacle (optional)

| | | | | | | | |
|-----------------|--------|--------|-----------|--------|--------|--------|----------------------------------|
| Receptacle type | | | | | | | |
| | TYPE-A | TYPE-B | TYPE-C | TYPE-D | TYPE-E | TYPE-F | (Terminal only) |
| Country | USA | EUROPE | AUSTRALIA | U.K | JAPAN | GFCI | ---- |
| Certificate | FC | E13 CE | E13 CE | E13 CE | FC | FC | cUL US FC (Except for 48V input) |

Mechanical Specification

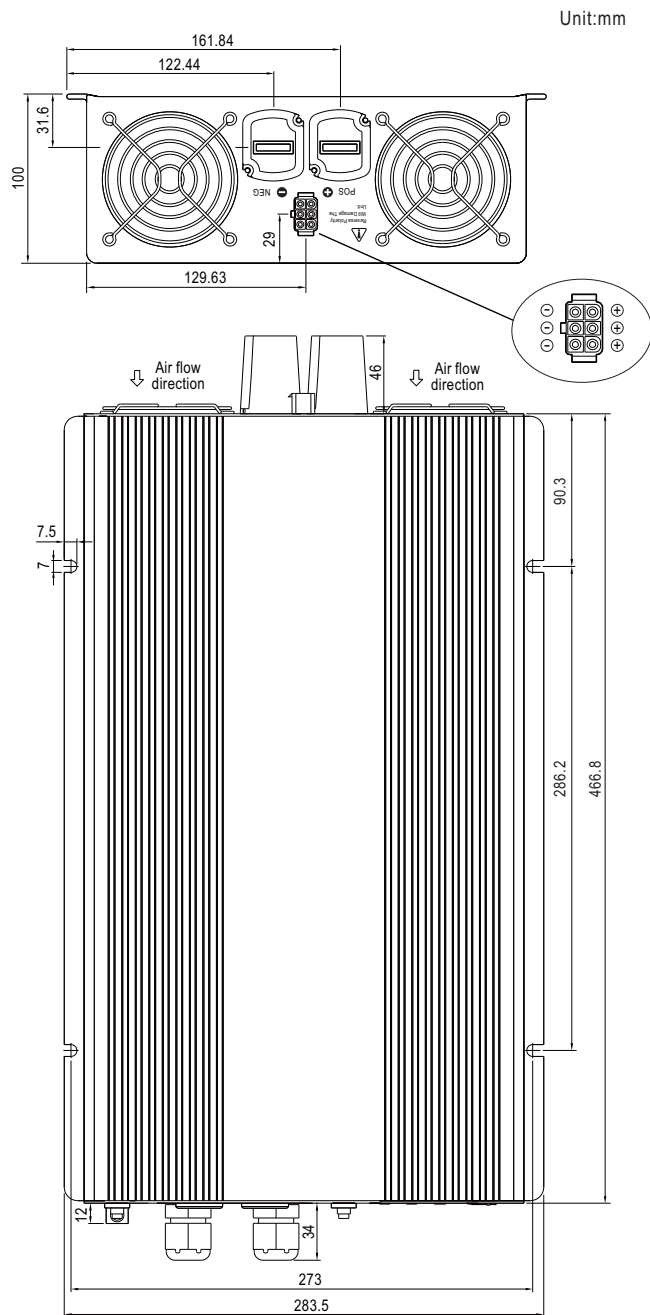

Derating Curve

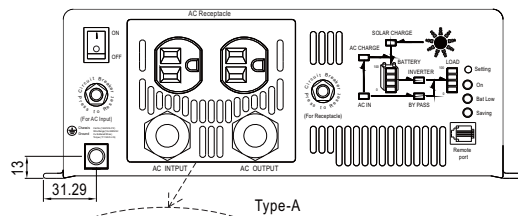
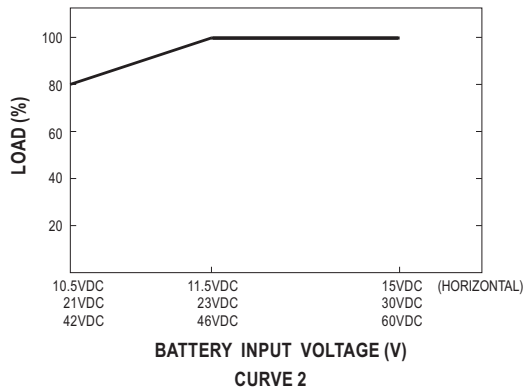
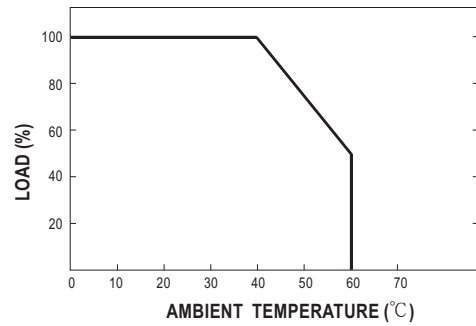

Note: When the load current is >15A, must use output terminal connection which can be found inside the AC output panel of the inverter.

